



CATALOGO GENERALE
DUEMILAVENTUNO

"L'economia è una virtù distributiva: non consiste nel risparmiare, bensì nel saper scegliere".

Così scriveva Edmund Burke (economista) nel 1796, ed è così che oggi Rosy e Fabio, della Assisi snc, guardano ai loro clienti e al futuro.

Fondata nel lontano 1977 da Assisi Salvatore, inizialmente nel territorio Piemontese per poi estendersi su tutto il Nord-Ovest .

Assisi snc si distingue maggiormente nella capillare distribuzione di materiale elettrico, elettronico ed illuminazione, acquisendo con il tempo sempre più esperienza e prestigio con i grandi leader di mercato del periodo.

Dopo oltre 40 anni, la Assisi snc ha assunto un approccio sempre più globale e attento nella gamma dei prodotti distribuiti, sempre alla ricerca di nuove opportunità e nuove esperienze....

...arrivando ad Oggi, nel 2021, Fabio e Rosy Assisi, inaugurano il loro nuovo marchio: Kontakt



Nella speranza di offrire ai loro clienti l'attenzione e il rispetto di sempre, uniti da innovazione e affidabilità sempre crescenti.

Indice Generale

ELETTRIKO

<i>Spine e Prese</i> _____	3
<i>Adattatori</i> _____	9
<i>Prese Multiple</i> _____	13
<i>Prolunghe</i> _____	21
<i>Adattatori Industriali</i> _____	25
<i>Interruttori</i> _____	27

ANTENNISTIKA

<i>Cavo Coassiale in matassa</i> _____	29
<i>Cavi Coassiali intestati</i> _____	33
<i>Connettori Coassiali</i> _____	33

MINUTERIA

<i>Nastro Isolante</i> _____	35
<i>Fascette</i> _____	36
<i>Fascette Stringitubo</i> _____	37
<i>Chiodini Fermacavo</i> _____	37
<i>Mammut</i> _____	38
<i>Morsetti Unipolari</i> _____	39

ILLUMINAZIONE

<i>Lampade LED</i> _____	41
<i>Lampadine Speciali</i> _____	55
<i>Accessori Vintage Style</i> _____	58
<i>Torce LED</i> _____	64

TELEKOMANDI

<i>Telecomandi TV Universali</i> _____	71
<i>Telecomandi TV Programmabili</i> _____	72
<i>Radiocomandi Apricancello</i> _____	73



ELETTRIKO

<i>Spine e Prese</i>	_____	3
<i>Adattatori</i>	_____	9
<i>Prese Multiple</i>	_____	13
<i>Prolunghe</i>	_____	21
<i>Adattatori Industriali</i>	_____	25
<i>Interruttori</i>	_____	27

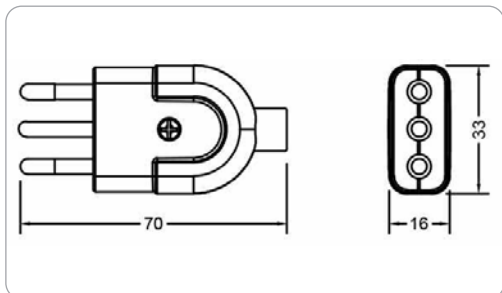





Spina Mobile 2P + T - 10 A



Codice Colore Confezione EAN13

CT1001B Bianco  50 pcs
 500 pcs 8 059016 270008

CT1001N Nero  50 pcs
 500 pcs 8 059016 270015

CT1001B-1 Bianco  1 pcs
 250 pcs 8 059016 271968

CT1001N-1 Nero  1 pcs
 250 pcs 8 059016 271975

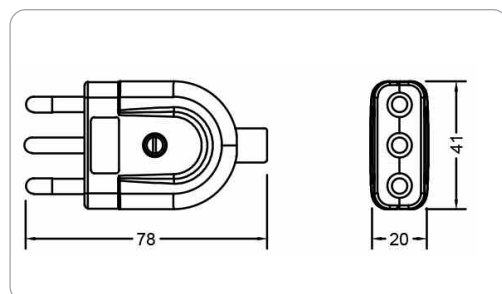



Spina Mobile 2P + T - 16 A



Codice Colore Confezione EAN13

CT1003B Bianco  35 pcs
 350 pcs 8 059016 270022

CT1003N Nero  35 pcs
 350 pcs 8 059016 270039

CT1003B-1 Bianco  1 pcs
 250 pcs 8 059016 272040

CT1003N-1 Nero  1 pcs
 250 pcs 8 059016 272057

Spina Mobile 2P + T - 10 A - 90°

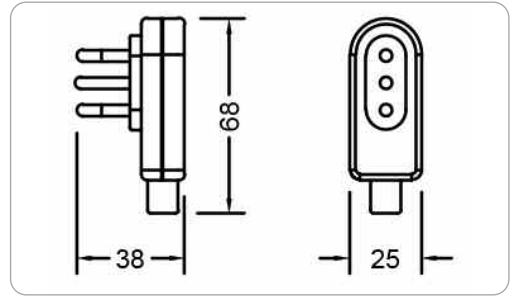

Codice	Colore	Confezione	EAN13
--------	--------	------------	-------

CT1005B	Bianco	40 pcs	
		400 pcs	
CT1005N	Nero	40 pcs	
		400 pcs	
CT1005B-1	Bianco	1 pcs	
		250 pcs	
CT1005N-1	Nero	1 pcs	
		250 pcs	

Spina Mobile 2P + T - 16 A - 90°

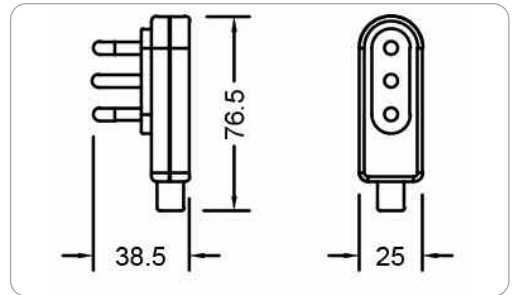

Codice	Colore	Confezione	EAN13
--------	--------	------------	-------

CT1006B	Bianco	30 pcs	
		300 pcs	
CT1006N	Nero	30 pcs	
		300 pcs	
CT1006B-1	Bianco	1 pcs	
		250 pcs	
CT1006N-1	Nero	1 pcs	
		250 pcs	

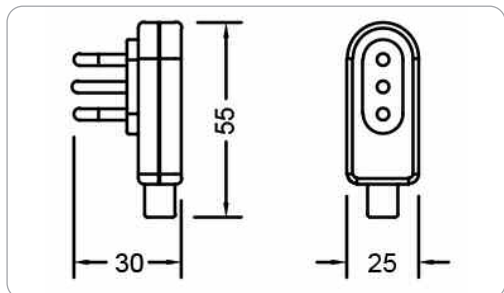

Spina Mobile 2P + T - 10 A - Basso profilo



Codice Colore Confezione EAN13

CT1005BSP Bianco 50 pcs
 500 pcs 8 059016 270060

CT1005NSP Nero 50 pcs
 500 pcs 8 059016 270077

CT1005BSP-1 Bianco 1 pcs
 250 pcs 8 059016 272002

CT1005NSP-1 Nero 1 pcs
 250 pcs 8 059016 272019

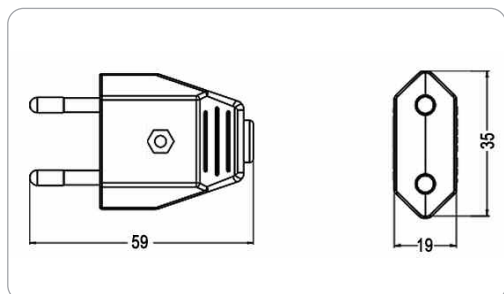

Spina Mobile 2P - 10 A



Codice Colore Confezione EAN13

CT1000B Bianco 50 pcs
 500 pcs 8 059016 270190

CT1000N Nero 50 pcs
 500 pcs 8 059016 270206

CT1000B-1 Bianco 1 pcs
 250 pcs 8 059016 272026

CT1000N-1 Nero 1 pcs
 250 pcs 8 059016 272033



Spina Mobile Schuko francese - 16 A

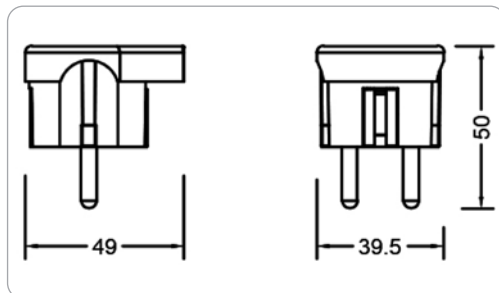

Codice	Colore	Confezione	EAN13
--------	--------	------------	-------

CT1019B	Bianco	25 pcs	8 059016 270312
		250 pcs	

CT1019N	Nero	25 pcs	8 059016 270329
		250 pcs	

CT1019B-1	Bianco	1 pcs	8 059016 272118
		250 pcs	

CT1019N-1	Nero	1 pcs	8 059016 272125
		250 pcs	

Spina Mobile Schuko 16 A - 90°

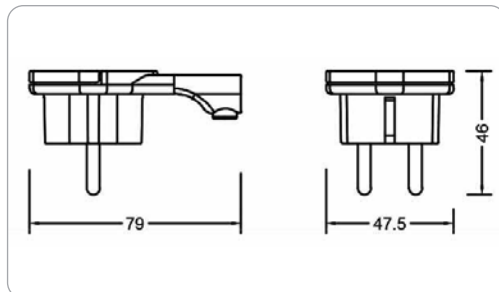

Codice	Colore	Confezione	EAN13
--------	--------	------------	-------

CT1007B	Bianco	20 pcs	8 059016 270107
		200 pcs	

CT1007B-1	Bianco	1 pcs	8 059016 272088
		200 pcs	

Spina Mobile Schuko - 16 A

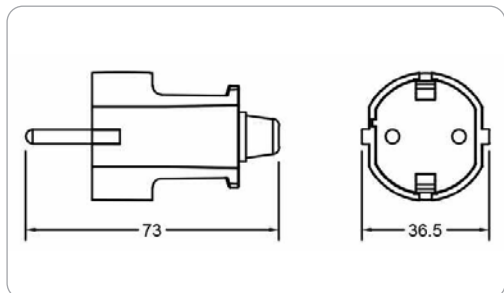

Codice	Colore	Confezione	EAN13
--------	--------	------------	-------

CT1008B	Bianco	25 pcs	8 059016 270282
		250 pcs	

CT1008N	Nero	25 pcs	8 059016 270299
		250 pcs	

CT1008B-1	Bianco	1 pcs	8 059016 272095
		250 pcs	

CT1008N-1	Nero	1 pcs	8 059016 272101
		250 pcs	

Preso Mobile Universale 2P + T - 16 A

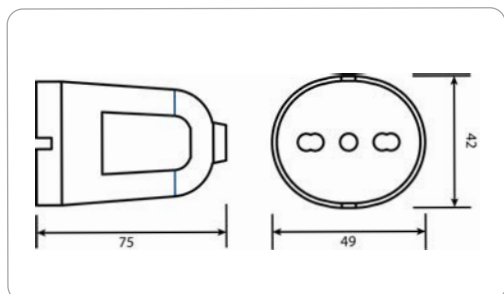

Codice	Colore	Confezione	EAN13
--------	--------	------------	-------

CT1018B	Bianco	25 pcs	8 059016 270336
		250 pcs	

CT1018N	Nero	25 pcs	8 059016 270343
		250 pcs	

CT1018B-1	Bianco	1 pcs	8 059016 272309
		250 pcs	

CT1018N-1	Nero	1 pcs	8 059016 272316
		250 pcs	

Presse Mobile 2 P + T - 10 A

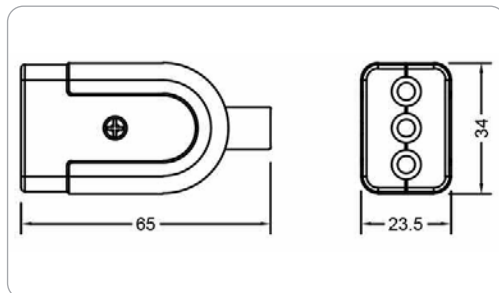

Codice	Colore	Confezione	EAN13
--------	--------	------------	-------

CT1002B	Bianco	40 pcs	8 059016 270114
		400 pcs	
CT1002N	Nero	40 pcs	8 059016 270121
		400 pcs	
CT1002B-1	Bianco	1 pcs	8 059016 272262
		250 pcs	
CT1002N-1	Nero	1 pcs	8 059016 272279
		250 pcs	

Presse Mobile Bipasso 2P + T - 16 A

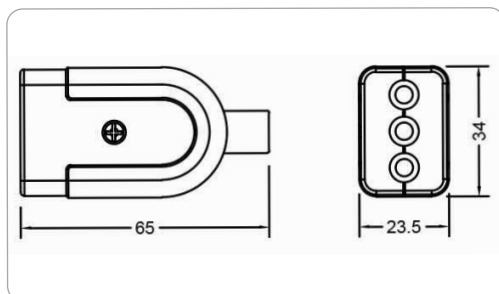

Codice	Colore	Confezione	EAN13
--------	--------	------------	-------

CT1004B	Bianco	25 pcs	8 059016 270138
		250 pcs	
CT1004N	Nero	25 pcs	8 059016 270145
		250 pcs	
CT1004B-1	Bianco	1 pcs	8 059016 272286
		250 pcs	
CT1004N-1	Nero	1 pcs	8 059016 272293
		250 pcs	

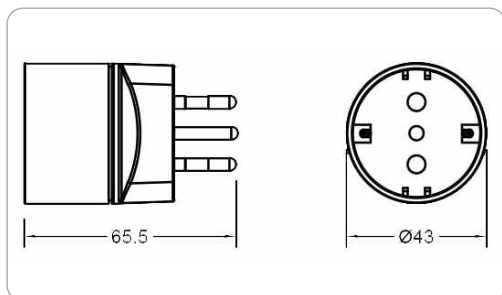
Adattatore Spina 10 A - Presa Schuko



Codice	Colore	Confezione	EAN13
--------	--------	------------	-------

CT1015B	Bianco	25 pcs	8 059016 270152
		250 pcs	

CT1015N	Nero	25 pcs	8 059016 270169
		250 pcs	

CT1015B-1	Bianco	1 pcs	8 059016 272156
		250 pcs	

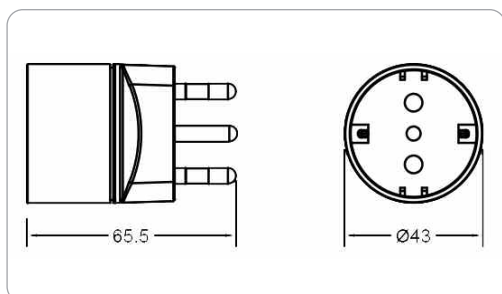
CT1015N-1	Nero	1 pcs	8 059016 272163
		250 pcs	

Adattatore Spina 16 A - Presa Schuko

Codice	Colore	Confezione	EAN13
--------	--------	------------	-------

CT1016B	Bianco	25 pcs	8 059016 270176
		250 pcs	

CT1016N	Nero	25 pcs	8 059016 270183
		250 pcs	

CT1016B-1	Bianco	1 pcs	8 059016 272132
		250 pcs	

CT1016N-1	Nero	1 pcs	8 059016 272149
		250 pcs	

Adattatore Spina 16 A - 3 prese Bipasso

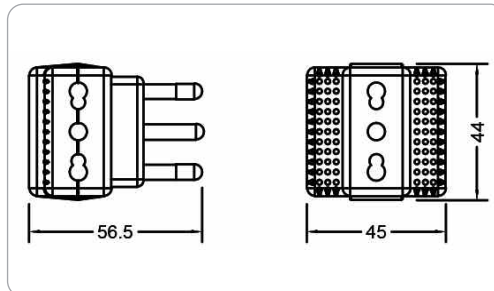

Codice	Colore	Confezione	EAN13
--------	--------	------------	-------

CT1010B	Bianco	25 pcs	8 059016 270213
		250 pcs	

CT1010N	Nero	25 pcs	8 059016 270220
		250 pcs	

CT1010B-1	Bianco	1 pcs	8 059016 272194
		250 pcs	

CT1010N-1	Nero	1 pcs	8 059016 272200
		250 pcs	

Adattatore Spina 16 A - Presa Universale + 2 Prese Bipasso

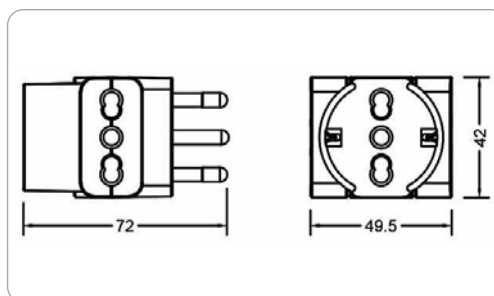

Codice	Colore	Confezione	EAN13
--------	--------	------------	-------

CT1012B	Bianco	25 pcs	8 059016 270237
		250 pcs	

CT1012N	Nero	25 pcs	8 059016 270244
		250 pcs	

CT1012B-1	Bianco	1 pcs	8 059016 272224
		250 pcs	

CT1012N-1	Nero	1 pcs	8 059016 272231
		250 pcs	

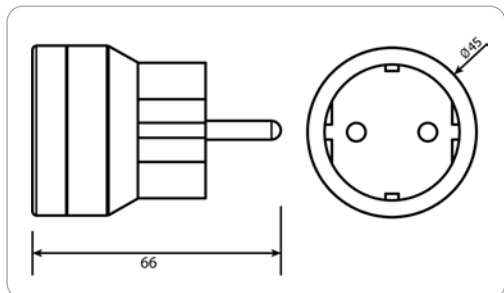
Adattatore Spina Schuko - Presa Bipasso

Codice	Colore	Confezione	EAN13
--------	--------	------------	-------

CT1014B	Bianco	25 pcs	8 059016 270251
		250 pcs	

CT1014N	Nero	25 pcs	8 059016 270268
		250 pcs	

CT1014B-1	Bianco	1 pcs	8 059016 272170
		250 pcs	

CT1014N-1	Nero	1 pcs	8 059016 272187
		250 pcs	

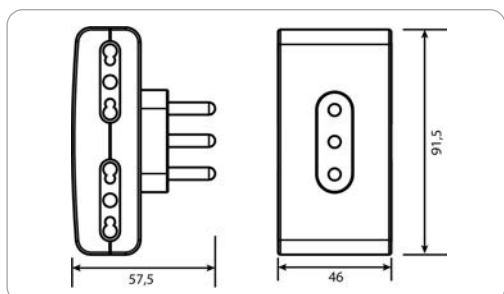
Adattatore Spina 16 A - 4 prese Bipasso

Codice	Colore	Confezione	EAN13
--------	--------	------------	-------

CT1017B	Bianco	10 pcs	8 059016 270275
		100 pcs	

CT1017B-1	Bianco	1 pcs	8 059016 272217
		100 pcs	





**Adattatore Spina 16 A - 2 Prese Bipasso +
2 Prese USB - 2100 mA max**

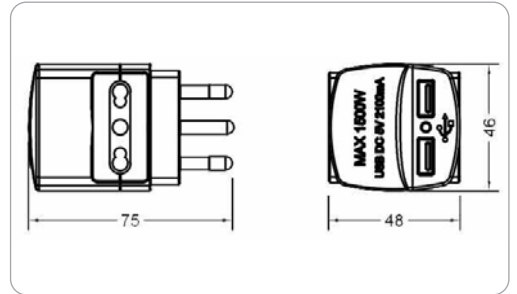

Codice Colore Confezione EAN13

CT1020B	Bianco	20 pcs	
		200 pcs	

CT1020B-1	Bianco	1 pcs	
		200 pcs	

**Adattatore Spina 10 A - 1 Presa Universale +
2 Prese Bipasso - MAGNETOTERMICO 10 A**



Caratteristiche

- Magnetotermico di protezione anti-sovraccarico (10 A - 250 V)
- 1500 Watt Max - Alveoli protetti - Dimensioni : 77 x 72 x 48 mm

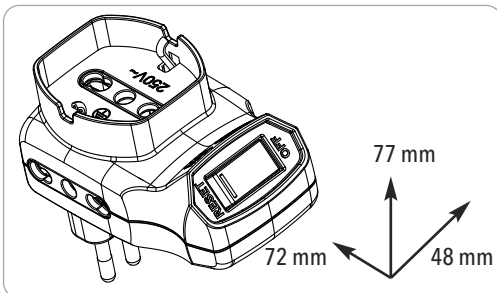

Codice Colore Confezione EAN13

CT1021B	Bianco	1 pcs	
		100 pcs	



Presa Multipla 3 Prese Universali Con Interruttore Luminoso



Caratteristiche

- Cavo H05VV-F3G 1,0 mm² con Spina 16 A - 1,5 mt
- 3500 Watt Max - Alveoli protetti - Dimensioni : 211 x 52 x 40 mm

Codice	Colore	Confezione	EAN13
--------	--------	------------	-------

CT2003B	Bianco	1 pcs 25 pcs	8 059016 270428
---------	--------	-----------------	-----------------

CT2003N	Nero	1 pcs 25 pcs	8 059016 270435
---------	------	-----------------	-----------------

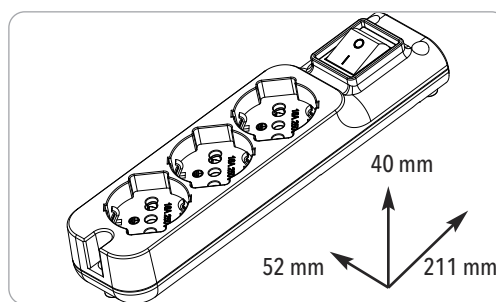

Presa Multipla 4 Prese Universali Con Interruttore Luminoso



Caratteristiche

- Cavo H05VV-F3G 1,0 mm² con Spina 16 A - 1,5 mt
- 3500 Watt Max - Alveoli protetti - Dimensioni : 253 x 52 x 40 mm

Codice	Colore	Confezione	EAN13
--------	--------	------------	-------

CT2004B	Bianco	1 pcs 25 pcs	8 059016 270442
---------	--------	-----------------	-----------------

CT2004N	Nero	1 pcs 25 pcs	8 059016 270459
---------	------	-----------------	-----------------

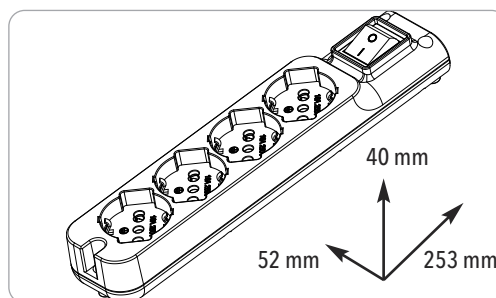



**Presa Multipla 5 Prese Universali
Con Interruttore Luminoso**



Caratteristiche

- Cavo H05VV-F3G 1,0 mm² con Spina 16 A - 1,5 mt
- 3500 Watt Max - Alveoli protetti - Dimensioni : 296 x 52 x 40 mm

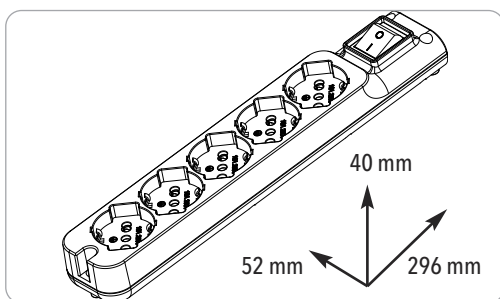

Codice	Colore	Confezione	EAN13
--------	--------	------------	-------

CT2005B	Bianco	1 pcs	
		25 pcs	

CT2005N	Nero	1 pcs	
		25 pcs	

**Presa Multipla 6 Prese Universali
Con Interruttore Luminoso**



Caratteristiche

- Cavo H05VV-F3G 1,0 mm² con Spina 16 A - 1,5 mt
- 3500 Watt Max - Alveoli protetti - Dimensioni : 338 x 52 x 40 mm

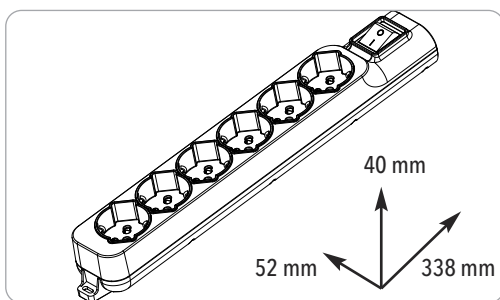

Codice	Colore	Confezione	EAN13
--------	--------	------------	-------

CT2006B	Bianco	1 pcs	
		25 pcs	

CT2006N	Nero	1 pcs	
		25 pcs	



Presa Multipla 1 Presa Universale + 2 Prese Bipasso



Caratteristiche

- Cavo H05VV-F3G 1,0 mm² con Spina 16 A - 1,5 mt
- 3500 Watt Max - Alveoli protetti - Dimensioni : 94 x 49 x 46,5 mm

Codice	Colore	Confezione	EAN13
--------	--------	------------	-------

CT2013B	Bianco	1 pcs 25 pcs	8 059016 270398
---------	--------	-----------------	-----------------

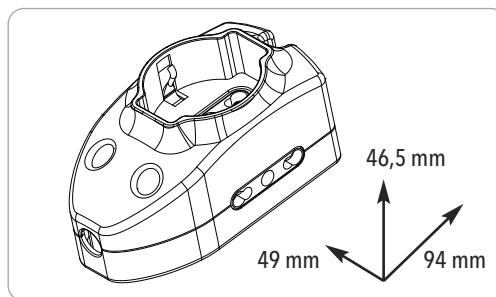

Presa Multipla 1 Presa Universale + 2 Prese Bipasso + 2 Porte USB (2,1 A)



Caratteristiche

- Cavo H05VV-F3G 1,5 mm² con Spina 16 A - 1,5 mt
- 3500 Watt Max - Alveoli protetti - Dimensioni : 170 x 51 x 40,5 mm
- 2 Porte USB tipo A - Max 2100 mA

Codice	Colore	Confezione	EAN13
--------	--------	------------	-------

CT2012USB	Bianco	1 pcs 25 pcs	8 059016 270541
-----------	--------	-----------------	-----------------

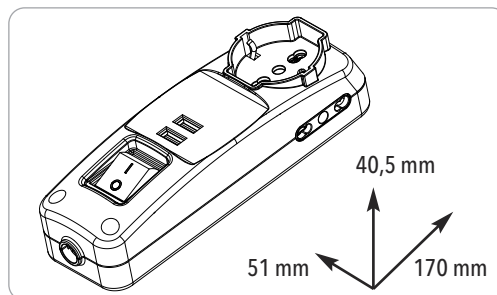



Presa Multipla 2 Prese Universali + 4 Prese Bipasso - Con Interruttore Luminoso

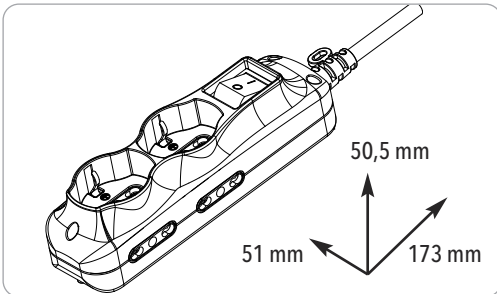
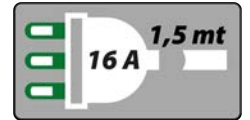

Caratteristiche

- Cavo H05VV-F3G 1,0 mm² con Spina 16 A - 1,5 mt
- 3500 Watt Max - Alveoli protetti - Dimensioni : 173 x 51 x 50,5 mm

Codice	Colore	Confezione	EAN13
--------	--------	------------	-------

CT2014B	Bianco	1 pcs 25 pcs	8 059016 270404
---------	--------	-----------------	-----------------

Presa Multipla 3 Prese Universali + 6 Prese Bipasso - Con Interruttore Luminoso

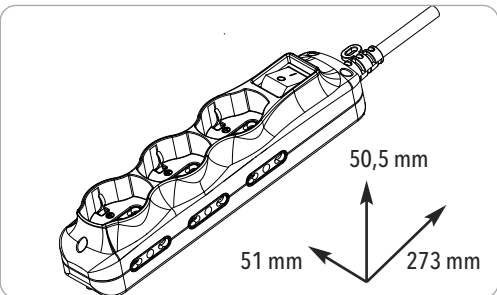

Caratteristiche

- Cavo H05VV-F3G 1,0 mm² con Spina 16 A - 1,5 mt
- 3500 Watt Max - Alveoli protetti - Dimensioni : 273 x 51 x 50,5 mm

Codice	Colore	Confezione	EAN13
--------	--------	------------	-------

CT2015B	Bianco	1 pcs 25 pcs	8 059016 270411
---------	--------	-----------------	-----------------



Presa Multipla *senza cavo* 3 Prese Universali Con Interruttore Luminoso



Vano inserimento cavo con morsetti a vite e cavallotto fermacavo

Caratteristiche

- 3500 Watt Max - Alveoli protetti
- Dimensioni : 231 x 52 x 40 mm

Codice	Colore	Confezione	EAN13
--------	--------	------------	-------

CT2008BSC	Bianco	1 pcs	8 059016 270503
		50 pcs	

CT2008NSC	Nero	1 pcs	8 059016 270510
		50 pcs	

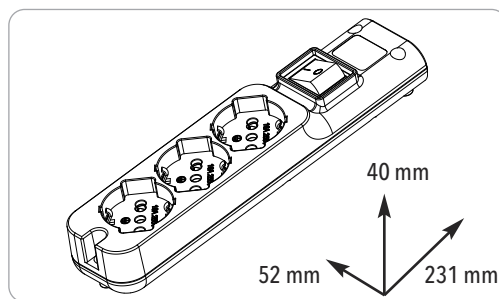

Presa Multipla *senza cavo* 4 Prese Universali Con Interruttore Luminoso



Vano inserimento cavo con morsetti a vite e cavallotto fermacavo

Caratteristiche

- 3500 Watt Max - Alveoli protetti
- Dimensioni : 273 x 52 x 40 mm

Codice	Colore	Confezione	EAN13
--------	--------	------------	-------

CT2009BSC	Bianco	1 pcs	8 059016 270527
		50 pcs	

CT2009NSC	Nero	1 pcs	8 059016 270534
		50 pcs	

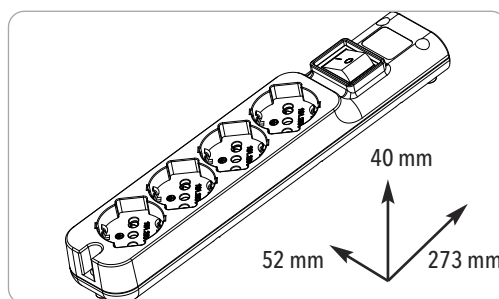



Presa Multipla SLIM 3 Prese Bipasso con MAGNETOTERMICO 10 A



Caratteristiche

- Magnetotermico di protezione anti-sovraccarico (10 A - 250 V)
- Cavo H05VV-F3G 1,0 mm² con Spina 10 A - 1,5 mt
- 3500 Watt Max - Alveoli protetti - Dimensioni : 260 x 27 x 22 mm

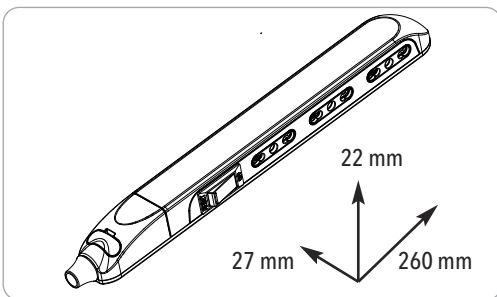

Codice	Colore	Confezione	EAN13
CT2103B	Bianco	1 pcs 25 pcs	



Presa Multipla 3 Prese Universali con MAGNETOTERMICO 10 A



Caratteristiche

- Magnetotermico di protezione anti-sovraccarico (10 A - 250 V)
- Cavo H05VV-F3G 1,0 mm² con Spina 10 A - 1,5 mt
- 2300 Watt Max - Alveoli protetti - Dimensioni : 213 x 54 x 39 mm

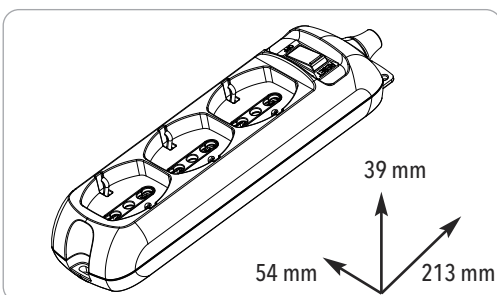

Codice	Colore	Confezione	EAN13
CT2020B	Bianco	1 pcs 25 pcs	





Presa Multipla 4 Prese Universali con MAGNETOTERMICO 10 A

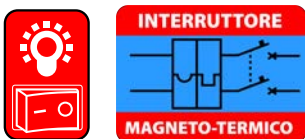

Caratteristiche

- Magnetotermico di protezione anti-sovraccarico (10 A - 250 V)
- Cavo H05VV-F3G 1,0 mm² con Spina 10 A - 1,5 mt
- 2300 Watt Max - Alveoli protetti - Dimensioni : 258 x 54 x 39 mm

Codice Colore Confezione EAN13

CT2021B Bianco 1 pcs
25 pcs 8 059016 270824

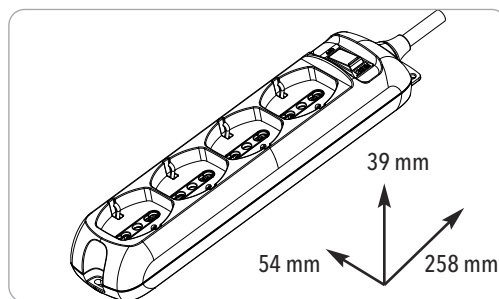

Presa Multipla 4 Prese Universali con MAGNETOTERMICO 10 A

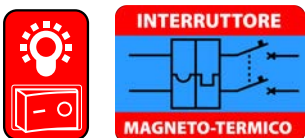

Caratteristiche

- Magnetotermico di protezione anti-sovraccarico (10 A - 250 V)
- Cavo H05VV-F3G 1,0 mm² con Spina 10 A - 1,5 mt
- 2300 Watt Max - Alveoli protetti - Dimensioni : 168 x 97 x 40 mm

Codice Colore Confezione EAN13

CT2010B Bianco 1 pcs
25 pcs 8 059016 270602

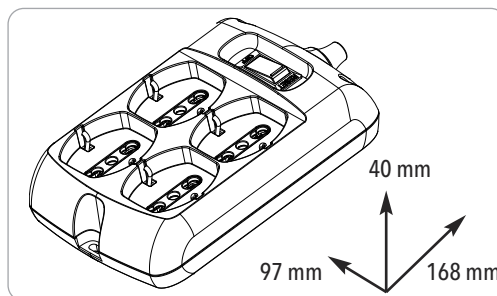



**Presa Multipla 6 Prese Universali
con MAGNETOTERMICO 10 A**

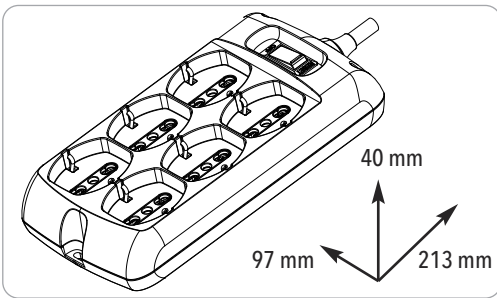
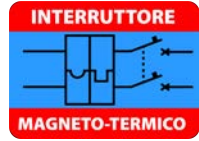

Caratteristiche

- Magnetotermico di protezione anti-sovraccarico (10 A - 250 V)
- Cavo H05VV-F3G 1,0 mm² con Spina 10 A - 1,5 mt
- 2300 Watt Max - Alveoli protetti - Dimensioni : 213 x 97 x 40 mm

Codice	Colore	Confezione	EAN13
--------	--------	------------	-------

CT2011B	Bianco	1 pcs 25 pcs	 8 059016 270619
---------	--------	-----------------	---------------------



Prolunga Spina / Presa 2P + T - 10 A
Cavo 3 x 0,75 mm²

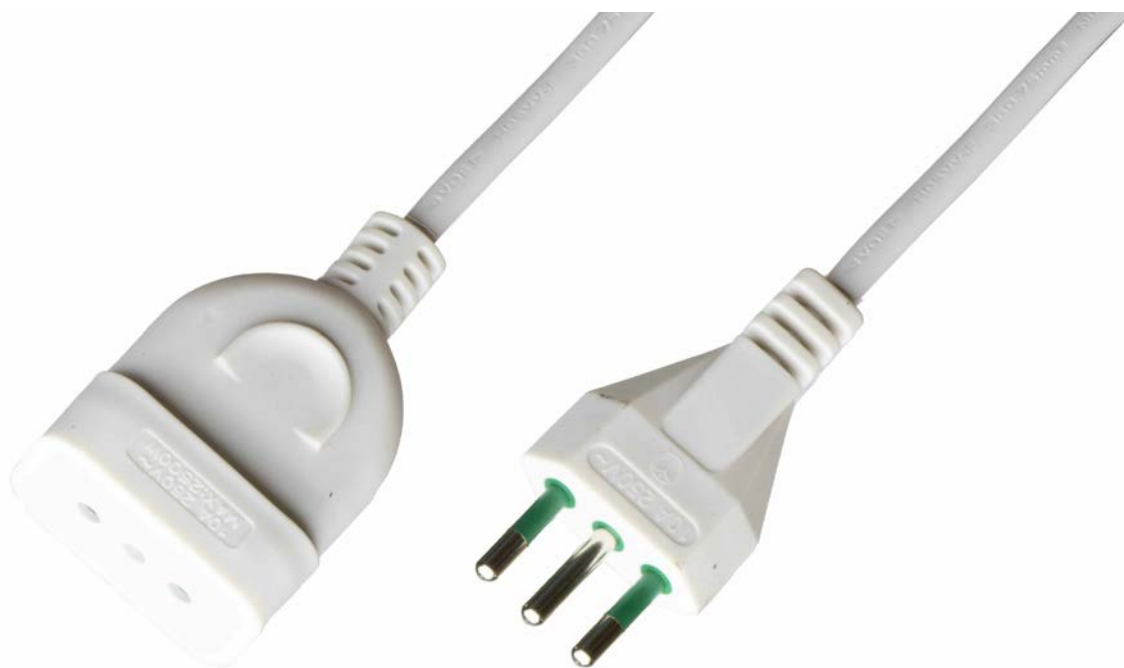

Codice	Colore	Lunghezza	Confezione	EAN13
CT3001B	Bianco	2 mt	1 pcs 25 pcs	8 059016 270671
CT3001N	Nero	2 mt	1 pcs 25 pcs	8 059016 270688
CT3002B	Bianco	3 mt	1 pcs 25 pcs	8 059016 270695
CT3002N	Nero	3 mt	1 pcs 25 pcs	8 059016 270701
CT3003B	Bianco	5 mt	1 pcs 25 pcs	8 059016 270718
CT3003N	Nero	5 mt	1 pcs 25 pcs	8 059016 270725

Prolunga Spina / Presa Bipasso 2P + T - 16 A
Cavo 3 x 1,00 mm²

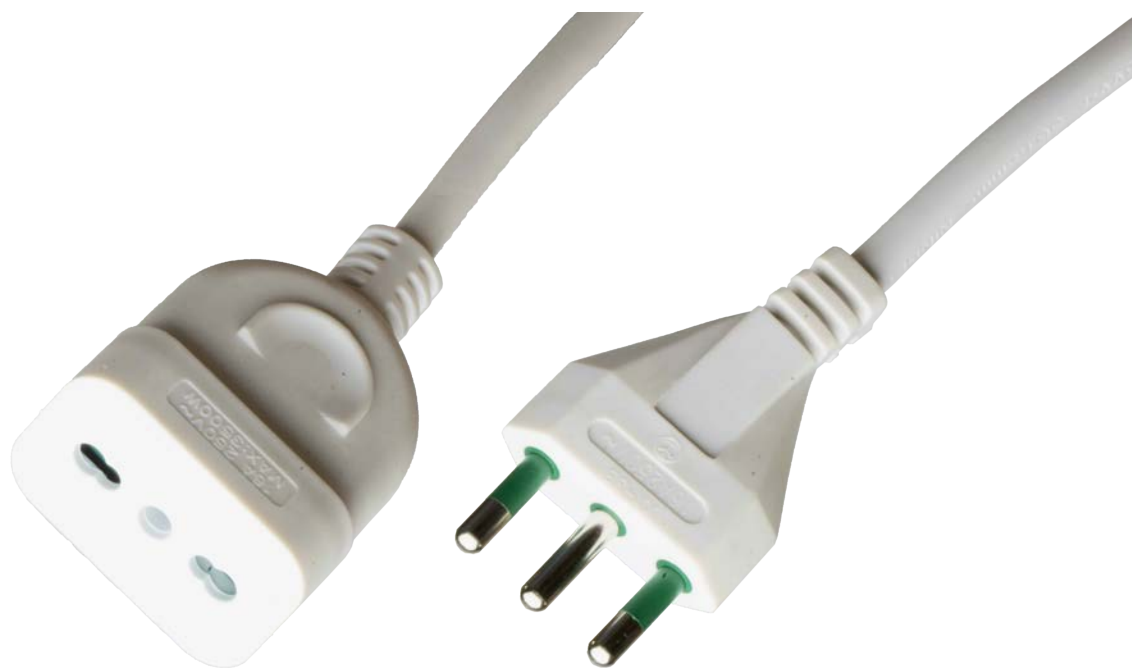

Codice	Colore	Lunghezza	Confezione	EAN13
CT3004B	Bianco	3 mt	1 pcs 25 pcs	8 059016 270633
CT3004N	Nero	3 mt	1 pcs 25 pcs	8 059016 270640
CT3005B	Bianco	5 mt	1 pcs 25 pcs	8 059016 270657
CT3005N	Nero	5 mt	1 pcs 25 pcs	8 059016 270664



Prolunga Spina / Presa Bipasso 2P + T - 16 A
Cavo 3 x 1,50 mm²

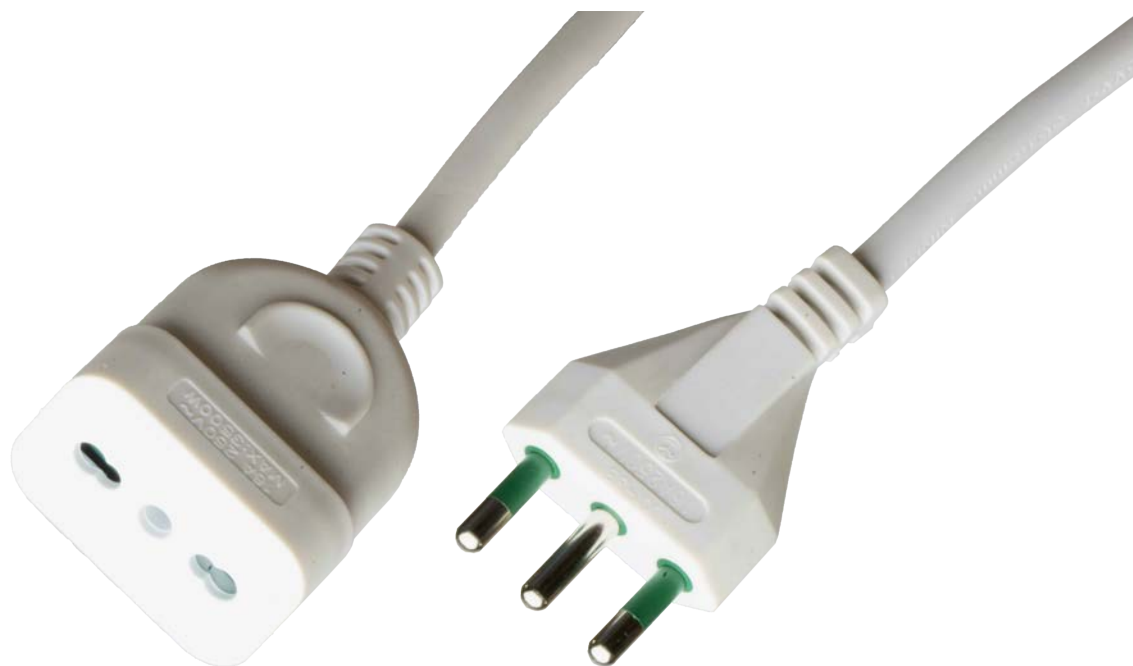

Codice	Colore	Lunghezza	Confezione	EAN13
--------	--------	-----------	------------	-------

CT3006B	Bianco	3 mt	1 pcs 25 pcs	8 059016 270732
CT3006N	Nero	3 mt	1 pcs 25 pcs	8 059016 270749
CT3007B	Bianco	5 mt	1 pcs 25 pcs	8 059016 270756
CT3007N	Nero	5 mt	1 pcs 25 pcs	8 059016 270763
CT3008B	Bianco	10 mt	1 pcs 10 pcs	8 059016 270770
CT3008N	Nero	10 mt	1 pcs 10 pcs	8 059016 270787



Prolunga Spina 16 A - Presa Universale
 Cavo 3 x 1,5 mm² - **Extraflessibile Per Esterni**



Codice	Colore	Lunghezza	Confezione	EAN13
CT3010A	Arancio	10 mt	1 pcs 10 pcs	8 059016 270794
CT3020A	Arancio	20 mt	1 pcs 6 pcs	8 059016 270800

**Adattatore Spina CEE 6H 2P+T
Presa Universale**

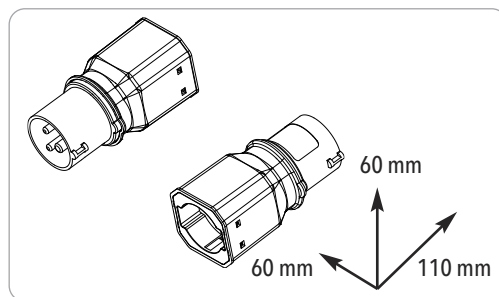

Codice Confezione EAN13

CT4001



10 pcs

100 pcs



8 059016 270367

**Adattatore Spina CEE 6H 2P+T
2 Prese Bipasso**

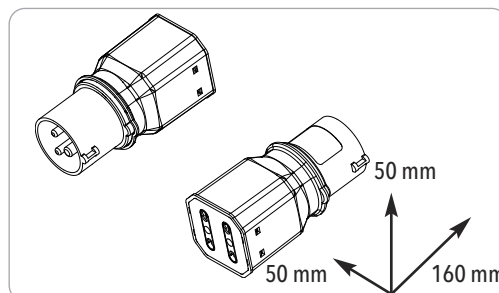

Codice Confezione EAN13

CT4002



10 pcs

100 pcs



8 059016 270350

**Adattatore Spina 2P+T 16 A
Preso CEE 6H 2P+T**

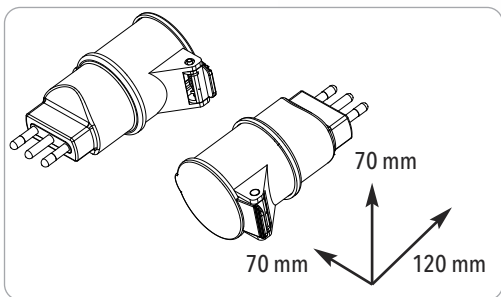

Codice	Confezione	EAN13
CT4003	10 pcs 100 pcs	8 059016 270374

**Adattatore Spina CEE 6H 2P+T
Preso Universale + 2 Bipasso**

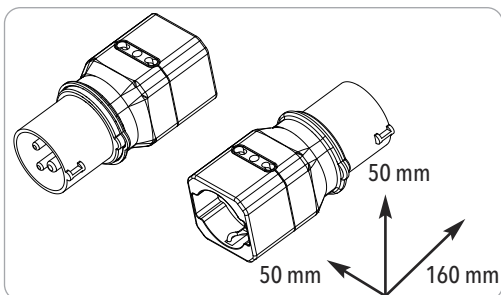



Codice	Confezione	EAN13
CT4004	10 pcs 100 pcs	8 059016 270381

Interruttore Passafilo Passante



Codice Colore Confezione EAN13

CT01B	Bianco	1 pcs	
		50 pcs	

CT01N	Nero	1 pcs	
		50 pcs	

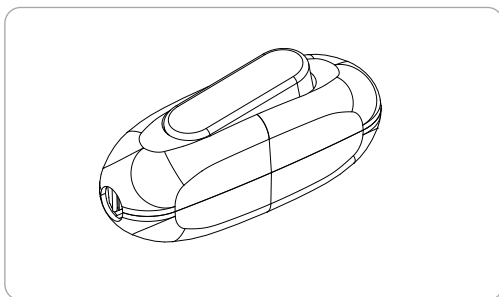

Interruttore Passafilo Terminale



Codice Colore Confezione EAN13

CT02B	Bianco	1 pcs	
		50 pcs	

CT02N	Nero	1 pcs	
		50 pcs	

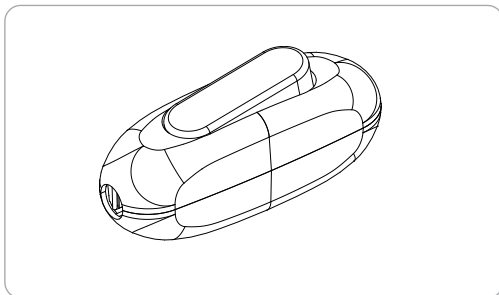



ANTENNISTIKA

<i>Cavo coassiale in matassa</i>	_____	29
<i>Cavi coassiali intestati</i>	_____	33
<i>Connettori coassiali</i>	_____	33



Cavo Coassiale 75 Ω - Ø 5,1 mm - CLASSE A+

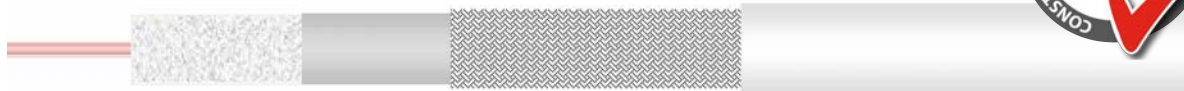

Conduttore	Isolante	Schermo	Isolante esterno
Rame Rosso Ø 0,82 mm	Schiuma PE Ø 3,4 mm	Foglio + Treccia Alluminio 64 fili da Ø 0,12 mm cad	PVC soft grip Ø 5,1 mm

Impedenza	75 Ohm
Velocità di propagazione	66 %
Perdite di riflessione	40 - 860 MHz - 30 dB
	860 - 2100 MHz - 22 dB
Efficienza schermatura	0 - 1000 MHz ≥ 85 dB
	1000 - 2000 MHz ≥ 75 dB
	2000 - 3000 MHz ≥ 67 dB

Attenuazione dB / 100 mt	5 MHz - 1,8 dB
	50 MHz - 6,5 dB
	450 MHz - 16 dB
	1000 MHz - 26,5 dB
	3000 MHz - 42 dB



Norme applicate : EN50117-2/1/4/5

Certificato CPR Reazione al fuoco : EN 13501-6:2014 - Eca Compliant

Codice

Confezione

EAN13

CTSATS150A  Roll Box 150 mt



8 059016 272347



Cavo Coassiale 75 Ω - Ø 6,8 mm - CLASSE A+

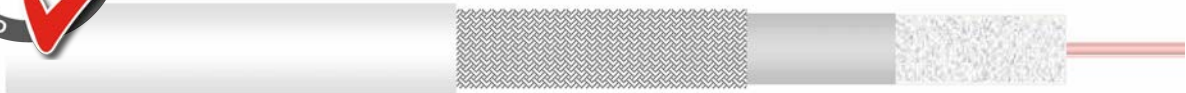

Isolante esterno	Schermo	Isolante	Conduttore
PVC soft grip Ø 6,8 mm	Foglio + Treccia Alluminio 64 fili da Ø 0,12 mm cad	Schiuma PE Ø 4,7 mm	Rame Rosso Ø 1,1 mm

Impedenza	75 Ohm
Velocità di propagazione	85 %
Perdite di riflessione	40 - 860 MHz - 27 dB
	860 - 2100 MHz - 22 dB
Efficienza schermatura	0 - 1000 MHz ≥ 90 dB
	1000 - 2000 MHz ≥ 85 dB
	2000 - 3000 MHz ≥ 75 dB

Attenuazione dB / 100 mt	5 MHz - 1,4 dB
	50 MHz - 5 dB
	450 MHz - 13,5 dB
	1000 MHz - 21 dB
	3000 MHz - 35,5 dB



Norme applicate : EN50117-2/1/4/5

Certificato CPR Reazione al fuoco : EN 13501-6:2014 - Eca Compliant

Codice **Confezione** **EAN13**

CTSAT7100A Roll Box 100 mt



8 059016 272354



Cavo Coassiale 75 Ω - Ø 5 mm - CLASSE B

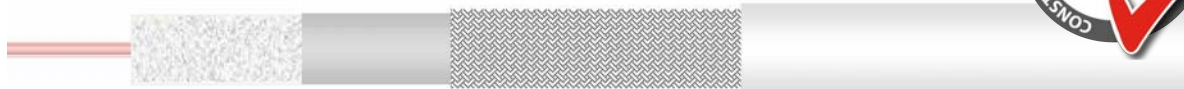

Conduttore	Isolante	Schermo	Isolante esterno
CCS Ø 0,80 mm	Schiuma PE Ø 3,4 mm	Foglio + Treccia Alluminio 64 fili da Ø 0,12 mm cad	PVC soft grip Ø 5,1 mm

Impedenza	75 Ohm
Velocità di propagazione	66 %
Perdite di riflessione	40 - 860 MHz - 28 dB
	860 - 2100 MHz - 19 dB
Efficienza schermatura	0 - 1000 MHz ≥ 85 dB
	1000 - 2000 MHz ≥ 75 dB
	2000 - 3000 MHz ≥ 67 dB

Attenuazione dB / 100 mt	5 MHz - 2 dB
	50 MHz - 7,1 dB
	450 MHz - 18 dB
	1000 MHz - 28 dB
	3000 MHz - 44 dB



Norme applicate : EN50117-2/1/4/5

Certificato CPR Reazione al fuoco : EN 13501-6:2014 - Eca Compliant

Codice Confezione EAN13

CTSAT5100B  Matassa 100 mt









8 059016 272323



Cavi Coassiali Spina - Spina TV 9,5 mm con adattatore Presa - Presa









Codice	Colore	Lunghezza	Confezione	EAN13
--------	--------	-----------	------------	-------



CTCOAX2MTB	Bianco	2 mt	 1 pcs  25 pcs	 8 059016 272545
-------------------	--------	------	---	---

CTCOAX2MTN	Nero	2 mt	 1 pcs  25 pcs	 8 059016 272576
-------------------	------	------	--	--

CTCOAX3MTB	Bianco	3 mt	 1 pcs  25 pcs	 8 059016 272552
-------------------	--------	------	---	---



CTCOAX3MTN	Nero	3 mt	 1 pcs  25 pcs	 8 059016 272583
-------------------	------	------	---	---

CTCOAX5MTB	Bianco	5 mt	 1 pcs  10 pcs	 8 059016 272569
-------------------	--------	------	---	---

CTCOAX5MTN	Nero	5 mt	 1 pcs  10 pcs	 8 059016 272590
-------------------	------	------	---	---

Spina Coassiale F ad avvitamento con o-ring

Codice	Diam.	Confezione	EAN13
--------	-------	------------	-------

CTSATC51F	Ø 5,1 mm	 Box  100 pcs	 8 059016 272644
------------------	----------	--	--

CTSATC68F	Ø 6,8 mm	 Box  100 pcs	 8 059016 272651
------------------	----------	--	--





MINUTERIA

<i>Nastro Isolante</i>	<u>35</u>
<i>Fascette</i>	<u>36</u>
<i>Fascette Stringitubo</i>	<u>37</u>
<i>Chiodini Fermacavo</i>	<u>37</u>
<i>Mammut</i>	<u>38</u>
<i>Morsetti Unipolari</i>	<u>39</u>

Nastro Isolante in PVC Autoestinguente

- Nastro monoadesivo isolante, in PVC plastificato con adesivo base gomma naturale
- Performante nella maggior parte degli impieghi più comuni ed adatto per cablaggi elettrici e fasciatura di cavi e conduttori.
- Disponibile in 4 colori.
- Conforme alla normativa CEI EN 60454-3-1 IEC 60454-3-1-5/F-PVCP/90.

CARATTERISTICHE TECNICHE

- Adesività: 5 N/25mm
- Carico/resistenza alla rottura : 70 N/25mm
- Resistenza all'allungamento : 230 %
- Spessore totale : 0,13 mm



Scala 1:1

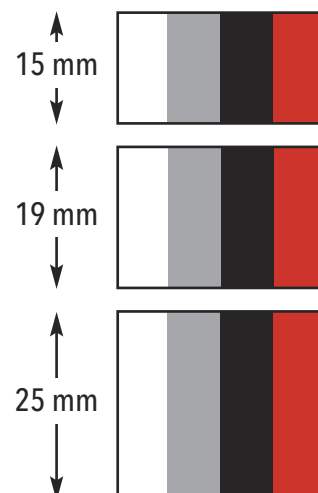

Dimensioni	BIANCO	GRIGIO	NERO	ROSSO	Confezione
15 mm x 10 mt	CT1510B 	CT1510G 	CT1510N 	CT1510R 	100 pcs 1000 pcs
	CT1925B 	CT1925G 	CT1925N 	CT1925R 	100 pcs 1000 pcs
25 mm x 25 mt	CT2525B 	CT2525G 	CT2525N 	CT2525R 	100 pcs 1000 pcs

Fascette in Nylon









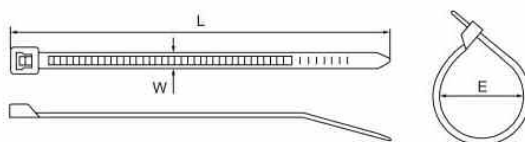





























Caratteristiche

- Materiale : Nylon

- Temperatura esercizio : - 40°C ≈ + 85°C



L x W		E			
Dimensioni	BIANCHE	NERE	Serraggio	Tenuta	Confezione
2,5 x 100	CT25100B 	CT25100N 	Ø 22 mm	8 Kg	 100 pcs
					 1000 pcs
3,6 x 140	CT36140B 	CT36140N 	Ø 33 mm	18 Kg	 100 pcs
					 1000 pcs
3,6 x 200	CT36200B 	CT36200N 	Ø 53 mm	18 Kg	 100 pcs
					 1000 pcs
3,6 x 300	CT36300B 	CT36300N 	Ø 80 mm	18 Kg	 100 pcs
					 1000 pcs
4,6 x 120	CT46120B 	CT46120N 	Ø 26 mm	22 Kg	 100 pcs
					 1000 pcs
4,6 x 180	CT46180B 	CT46180N 	Ø 46 mm	22 Kg	 100 pcs
					 1000 pcs
4,8 x 300	CT48300B 	CT48300N 	Ø 80 mm	24 Kg	 100 pcs
					 1000 pcs
4,8 x 350	CT48350B 	CT48350N 	Ø 90 mm	24 Kg	 100 pcs
					 1000 pcs
6,8 x 180	CT68180B 	CT68180N 	Ø 46 mm	38 Kg	 100 pcs
					 1000 pcs
6,8 x 250	CT68250B 	CT68250N 	Ø 65 mm	38 Kg	 100 pcs
					 1000 pcs

Fascette Stringitubo

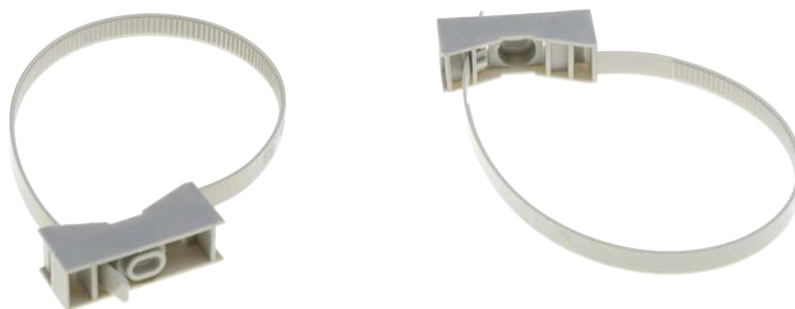

Codice	Dimensione	Confezione	EAN13
--------	------------	------------	-------

CT165STRING	Ø 16 - 32 mm	100 pcs	8 059016 271494
--------------------	--------------	---------	-----------------

CT285STRING	Ø 32 - 63 mm	100 pcs	8 059016 271500
--------------------	--------------	---------	-----------------

Chiodi Fermacavo



Caratteristiche

- Materiale : Polipropilene
- Colore : Bianco
- Chiodino in Acciaio

Codice	Dimensione	Confezione	EAN13
--------	------------	------------	-------

CT04CH	Ø 4 mm	100 pcs	8 059016 271630
---------------	--------	---------	-----------------

CT05CH	Ø 5 mm	100 pcs	8 059016 271647
---------------	--------	---------	-----------------

CT06CH	Ø 6 mm	100 pcs	8 059016 271654
---------------	--------	---------	-----------------

CT07CH	Ø 7 mm	100 pcs	8 059016 271661
---------------	--------	---------	-----------------

CT08CH	Ø 8 mm	100 pcs	8 059016 271678
---------------	--------	---------	-----------------

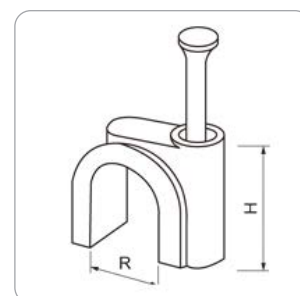

Codice	Dimensioni (mm)		
	H	R	Chiodo
CT04CH	5,3	4	1,7 x 15
CT05CH	6,3	5	1,7 x 15
CT06CH	7,4	6	1,85 x 16
CT07CH	8,4	7	1,85 x 18
CT08CH	9,4	8	1,95 x 19

Morsettiere Mammut



Stecche da 12 morsetti

Caratteristiche

- Materiale : Polipropilene
- Colore : Bianco
- Temperatura esercizio : $-40^{\circ}\text{C} \approx +110^{\circ}\text{C}$

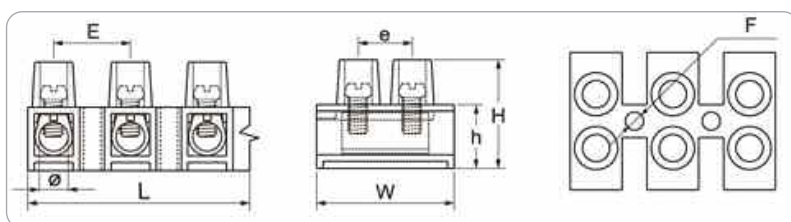

Codice	Dimensioni (mm)								Vite
	L	W	H	h	E	e	F	Ø	
CT025M	92,3	16,8	12,3	7,7	7,8	5,7	2,4	3,0	M2,5
CT04M	115,4	18,8	15,4	8,7	9,6	6,3	2,7	3,3	M3,0
CT06M	129,3	20,7	16,5	9,8	11,0	7,6	2,8	4,2	M3,0
CT10M	137,8	22,5	18,6	10,3	11,7	8,6	3,1	4,5	M3,5
CT12M	138,0	22,5	19,0	10,7	12,0	8,6	3,2	4,7	M4,0
CT16M	164,0	25,5	20,0	11,7	13,7	9,3	3,4	5,5	M4,0

Codice	Dimensione	Confezione	EAN13
--------	------------	------------	-------

CT025M	Ø 2,5 - 4 mm ²	 10 stecche	 8 059016 271630
---------------	---------------------------	--	--

CT04M	Ø 4 - 6 mm ²	 10 stecche	 8 059016 271647
--------------	-------------------------	--	--

CT06M	Ø 6 - 10 mm ²	 10 stecche	 8 059016 271654
--------------	--------------------------	--	--

CT10M	Ø 10 - 12 mm ²	 10 stecche	 8 059016 271661
--------------	---------------------------	--	--

CT12M	Ø 12 - 14 mm ²	 10 stecche	 8 059016 271678
--------------	---------------------------	--	--

CT16M	Ø 16 mm ²	 10 stecche	 8 059016 271685
--------------	----------------------	--	--

Morsetti Unipolari



Stecche da 10 morsetti

Codice	Dimensioni (mm)						Vite
	L	W	H	h	E	Ø	
CT015F	86,6	15,0	15,0	8,0	6,0	2,2	M3,5
CT025F	98,4	17,4	16,4	10,0	9,8	3,7	M3,5
CT04F	115,2	20,1	19,1	10,7	12,0	4,2	M3,5
CT06F	134,2	22,6	22,5	12,6	13,6	6,3	M5,0
CT10F	161,8	26,9	26,5	15,3	16,3	8,0	M6,0
CT16F	220,0	31,3	32,0	17,7	19,9	10,0	M8,0
CT25F	240,5	38,3	39,8	21,4	23,7	11,8	M10,0

Caratteristiche

- Materiale : Plastica
- Colore : Trasparente
- Temperatura esercizio : -35°C ≈ +120°C

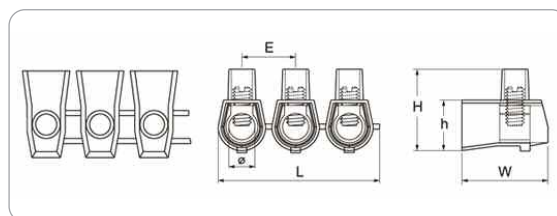

Codice	Sezione	Confezione	EAN13
--------	---------	------------	-------

CT015F

 1,5 mm²

 box 10
stecche

CT025F

 2,5 mm²

 box 10
stecche

CT04F

 4 mm²

 box 10
stecche

CT06F

 6 mm²

 box 10
stecche

CT10F

 10 mm²

 box 5
stecche

CT16F

 16 mm²

 box 5
stecche

CT25F

 25 mm²

 box 5
stecche



ILLUMINAZIONE

<i>Lampade LED</i>	<u>41</u>
<i>Lampadine Speciali</i>	<u>55</u>
<i>Accessori Vintage Style</i>	<u>58</u>
<i>Torçe LED</i>	<u>64</u>



Lampada LED a Goccia - 10 W - E27

CARATTERISTICHE TECNICHE

Accensione Istantanea - Grado di protezione : IP20 - Dimensioni : Ø 60 x 108 mm

Classe energetica A++ - CRI : >80% - Alimentazione : 220 / 240 Vac - 50 Hz

Prodotto privo di Mercurio



30.000 h



230°



E27



Non dimmerabile



Codice	Colore Luce	Confezione	EAN13
CT60102727	Calda - 2700°K	10 pcs 100 pcs	8 059016 270831
CT60102740	Naturale - 4000°K	10 pcs 100 pcs	8 059016 270848
CT60102765	Fredda - 6500°K	10 pcs 100 pcs	8 059016 270855



10 w = **75 w**

900 lumen

Lampada LED a Goccia - 12 W - E27

CARATTERISTICHE TECNICHE

Accensione Istantanea - Grado di protezione : IP20 - Dimensioni : Ø 60 x 118 mm

Classe energetica A++ - CRI : >80% - Alimentazione : 220 / 240 Vac - 50 Hz

Prodotto privo di Mercurio



30.000 h



230°



E27



Non dimmerabile



Codice	Colore Luce	Confezione	EAN13
CT60122727	Calda - 2700°K	10 pcs 100 pcs	8 059016 270862
CT60122740	Naturale - 4000°K	10 pcs 100 pcs	8 059016 270879
CT60122765	Fredda - 6500°K	10 pcs 100 pcs	8 059016 270886



12 w = **90 w**

1200 lumen



Lampada LED a Goccia - 17 W - E27



17 w = **120**W

1650 lumen

CARATTERISTICHE TECNICHE

Accensione Istantanea - Grado di protezione : IP20 - Dimensioni : Ø 70 x 128 mm
 Classe energetica A++ - CRI : >80% - Alimentazione : 220 / 240 Vac - 50 Hz
 Prodotto privo di Mercurio



Codice	Colore Luce	Confezione	EAN13
--------	-------------	------------	-------

CT60172727	Calda - 2700°K	10 pcs	8 059016 270893
		50 pcs	

CT60172740	Naturale - 4000°K	10 pcs	8 059016 270909
		50 pcs	

CT60172765	Fredda - 6500°K	10 pcs	8 059016 270916
		50 pcs	

Lampada LED a Oliva - 6 W - E14



6 w = **45**W

560 lumen

CARATTERISTICHE TECNICHE

Accensione Istantanea - Grado di protezione : IP20 - Dimensioni : Ø 37 x 100 mm
 Classe energetica A++ - CRI : >80% - Alimentazione : 220 / 240 Vac - 50 Hz
 Prodotto privo di Mercurio



Codice	Colore Luce	Confezione	EAN13
--------	-------------	------------	-------

CT37061427	Calda - 2700°K	10 pcs	8 059016 272361
		100 pcs	

CT37061440	Naturale - 4000°K	10 pcs	8 059016 272378
		100 pcs	

CT37061465	Fredda - 6500°K	10 pcs	8 059016 272385
		100 pcs	



Lampada LED a Oliva - 8 W - E14

CARATTERISTICHE TECNICHE

Accensione Istantanea - Grado di protezione : IP20 - Dimensioni : Ø 37 x 109 mm

Classe energetica A++ - CRI : >80% - Alimentazione : 220 / 240 Vac - 50 Hz

Prodotto privo di Mercurio



Codice	Colore Luce	Confezione	EAN13
CT37081427	Calda - 2700°K	10 pcs 100 pcs	8 059016 270947
CT37081440	Naturale - 4000°K	10 pcs 100 pcs	8 059016 270954
CT37081465	Fredda - 6500°K	10 pcs 100 pcs	8 059016 270961



8 w = **60 w**

720 lumen

Lampada LED a Sfera - 6 W - E14

CARATTERISTICHE TECNICHE

Accensione Istantanea - Grado di protezione : IP20 - Dimensioni : Ø 45 x 82 mm

Classe energetica A++ - CRI : >80% - Alimentazione : 220 / 240 Vac - 50 Hz

Prodotto privo di Mercurio



Codice	Colore Luce	Confezione	EAN13
CT45061427	Calda - 2700°K	10 pcs 100 pcs	8 059016 272392
CT45061440	Naturale - 4000°K	10 pcs 100 pcs	8 059016 272408
CT45061465	Fredda - 6500°K	10 pcs 100 pcs	8 059016 272415



6 w = **45 w**

560 lumen



Lampada LED a Sfera - 6 W - E27



6 w = **45 W**

560 lumen

CARATTERISTICHE TECNICHE

Accensione Istantanea - Grado di protezione : IP20 - Dimensioni : Ø 45 x 82 mm
 Classe energetica A++ - CRI : >80% - Alimentazione : 220 / 240 Vac - 50 Hz
 Prodotto privo di Mercurio



Codice	Colore Luce	Confezione	EAN13
CT45062727	Calda - 2700°K	10 pcs 100 pcs	8 059016 272422
CT45062740	Naturale - 4000°K	10 pcs 100 pcs	8 059016 272439
CT45062765	Fredda - 6500°K	10 pcs 100 pcs	8 059016 272446

Lampada LED a Sfera - 8 W - E14



8 w = **60 W**

720 lumen

CARATTERISTICHE TECNICHE

Accensione Istantanea - Grado di protezione : IP20 - Dimensioni : Ø 45 x 88 mm
 Classe energetica A++ - CRI : >80% - Alimentazione : 220 / 240 Vac - 50 Hz
 Prodotto privo di Mercurio



Codice	Colore Luce	Confezione	EAN13
CT45081427	Calda - 2700°K	10 pcs 100 pcs	8 059016 270978
CT45081440	Naturale - 4000°K	10 pcs 100 pcs	8 059016 270985
CT45081465	Fredda - 6500°K	10 pcs 100 pcs	8 059016 270992



Lampada LED a Sfera - 8 W - E27

CARATTERISTICHE TECNICHE

Accensione Istantanea - Grado di protezione : IP20 - Dimensioni : Ø 45 x 88 mm

Classe energetica A++ - CRI : >80% - Alimentazione : 220 / 240 Vac - 50 Hz

Prodotto privo di Mercurio



Codice	Colore Luce	Confezione	EAN13
CT45082727	Calda - 2700°K	10 pcs 100 pcs	8 059016 271005
CT45082740	Naturale - 4000°K	10 pcs 100 pcs	8 059016 271012
CT45082765	Fredda - 6500°K	10 pcs 100 pcs	8 059016 271029



8w = **60W**

720 lumen

Lampada LED a Globo - 18 W - E27

CARATTERISTICHE TECNICHE

Accensione Istantanea - Grado di protezione : IP20 - Dimensioni : Ø 120 x 165 mm

Classe energetica A++ - CRI : >80% - Alimentazione : 220 / 240 Vac - 50 Hz

Prodotto privo di Mercurio



Codice	Colore Luce	Confezione	EAN13
CT120182727	Calda - 2700°K	10 pcs 100 pcs	8 059016 272514
CT120182740	Naturale - 4000°K	10 pcs 100 pcs	8 059016 272521
CT120182765	Fredda - 6500°K	10 pcs 100 pcs	8 059016 272538



18w = **130W**

1700 lumen



Lampada LED a Globo - 24 W - E27



24 w = **200 w**
2600 lumen

CARATTERISTICHE TECNICHE

Accensione Istantanea - Grado di protezione : IP20 - Dimensioni : Ø 125 x 172 mm
Classe energetica A++ - CRI : >80% - Alimentazione : 220 / 240 Vac - 50 Hz
Prodotto privo di Mercurio



30.000 h



240°



E27



Non dimmerabile



Codice	Colore Luce	Confezione	EAN13
--------	-------------	------------	-------

CT125242727 *Calda* - 2700°K

10 pcs
25 pcs



CT125242740 *Naturale* - 4000°K

10 pcs
25 pcs



Lampada LED a Spot - 7 W - GU5.3



7 w = **50 w**
560 lumen

CARATTERISTICHE TECNICHE

Accensione Istantanea - Grado di protezione : IP20 - Dimensioni : Ø 50 x 55 mm
Classe energetica A++ - CRI : >80% - Alimentazione : 12 V
Prodotto privo di Mercurio



30.000 h



120°



GU5.3



Non dimmerabile



Codice	Colore Luce	Confezione	EAN13
--------	-------------	------------	-------

CTG530727 *Calda* - 2700°K

10 pcs
100 pcs



CTG530740 *Naturale* - 4000°K

10 pcs
100 pcs





Lampada LED a Spot - 7,5 W - GU10

CARATTERISTICHE TECNICHE

Accensione Istantanea - Grado di protezione : IP20 - Dimensioni : Ø 50 x 55 mm
 Classe energetica A++ - CRI : >80% - Alimentazione : 220 / 240 Vac - 50 Hz
 Prodotto privo di Mercurio



7,5 w = **55 w**
 640 lumen

Codice	Colore Luce	Confezione	EAN13
--------	-------------	------------	-------

CTG100827	Calda - 2700°K	10 pcs	
		100 pcs	

CTG100840	Naturale - 4000°K	10 pcs	
		100 pcs	

Lampada LED R50 - 7 W - E14

CARATTERISTICHE TECNICHE

Accensione Istantanea - Grado di protezione : IP20 - Dimensioni : Ø 50 x 85 mm
 Classe energetica A++ - CRI : >80% - Alimentazione : 220 / 240 Vac - 50 Hz
 Prodotto privo di Mercurio



7 w = **50 w**
 480 lumen

Codice	Colore Luce	Confezione	EAN13
--------	-------------	------------	-------

CTR50071430	Calda - 3000°K	10 pcs	
		100 pcs	

CTR50071440	Naturale - 4000°K	10 pcs	
		100 pcs	



Lampada LED R63 - 10 W - E27



10 w = **75 w**
720 lumen

CARATTERISTICHE TECNICHE

Accensione Istantanea - Grado di protezione : IP20 - Dimensioni : Ø 63 x 100 mm
Classe energetica A++ - CRI : >80% - Alimentazione : 220 / 240 Vac - 50 Hz
Prodotto privo di Mercurio



30.000 h



120°



E27



Non dimmerabile



Codice	Colore Luce	Confezione	EAN13
--------	-------------	------------	-------

CTR63102730 Calda - 3000°K



10 pcs

100 pcs



8 059016 272477

CTR63102740 Naturale - 4000°K



10 pcs

100 pcs



8 059016 272484

Lampada LED R80 - 15 W - E27



15 w = **100 w**
1250 lumen

CARATTERISTICHE TECNICHE

Accensione Istantanea - Grado di protezione : IP20 - Dimensioni : Ø 80 x 117 mm
Classe energetica A++ - CRI : >80% - Alimentazione : 220 / 240 Vac - 50 Hz
Prodotto privo di Mercurio



30.000 h



120°



E27



Non dimmerabile



Codice	Colore Luce	Confezione	EAN13
--------	-------------	------------	-------

CTR80152730 Calda - 3000°K



10 pcs

100 pcs



8 059016 272491

CTR80152740 Naturale - 4000°K



10 pcs

100 pcs



8 059016 272507



Lampadina Votiva a LED - E14

CARATTERISTICHE TECNICHE

Accensione istantanea - Grado di protezione : IP20 - Dimensioni : Ø 26 x 57 mm
 Classe energetica A - Alimentazione : 24 V
 Prodotto privo di Mercurio



E14



20.000 h



24 V



Non dimmerabile



Codice

Confezione

EAN13

CT2LC24



10 pcs

50 pcs



8 059016 271883

Lampadina Speciale a LED - G9

CARATTERISTICHE TECNICHE

Accensione Istantanea - Grado di protezione : IP20 - Dimensioni : Ø 14 x 42 mm
 Classe energetica A++ - CRI : >80% - Alimentazione : 220/240 Vac 50 Hz
 Prodotto privo di Mercurio



G9



20.000 h



220 V



3,5
Watt



Non dimmerabile



Codice

Colore Luce

Confezione

EAN13

CTG935220 Naturale - 4000°K



10 pcs

500 pcs



8 059016 271890

3,5 w = **35 w**

350 lumen

Lampadina Speciale a LED Colorata - E14

CT2G



CARATTERISTICHE TECNICHE

Accensione istantanea - Grado di protezione : IP20 - Dimensioni : Ø 26 x 57 mm
 Classe energetica A - Alimentazione : 220/240 Vac 50 Hz
 Prodotto privo di Mercurio

CT2BL



CT2R



CT2V



CT2W14B



E14



20.000 h



220 V



1
Watt



Non
dimmerabile

Codice	Confezione	EAN13
CT2G	10 pcs	8 059016 271838
	50 pcs	
CT2BL	10 pcs	8 059016 271845
	50 pcs	
CT2R	10 pcs	8 059016 271852
	50 pcs	
CT2V	10 pcs	8 059016 271869
	50 pcs	
CT2W14B	10 pcs	8 059016 271876
	50 pcs	

Lampada LED Filamento a Oliva - 4 W - E14

CARATTERISTICHE TECNICHE

Accensione Istantanea - Grado di protezione : IP20 - Dimensioni : Ø 37 x 98 mm
 Classe energetica A++ - CRI : >80% - Alimentazione : 220 / 240 Vac - 50 Hz
 Prodotto privo di Mercurio

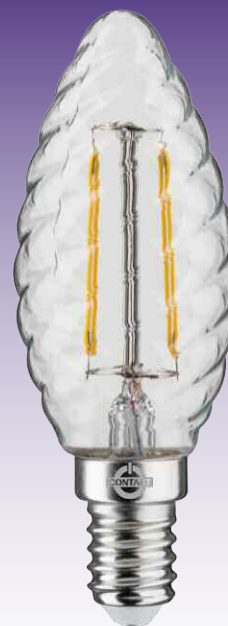

4 w = **40 W**

470 lumen

Codice	Colore Luce	Confezione	EAN13
--------	-------------	------------	-------

CTFLTOR041427CH	Calda - 2700°K	10 pcs 100 pcs	 8 059016 271074
-----------------	----------------	-------------------	---------------------

Lampada LED Filamento a Oliva - 4 W - E14

CARATTERISTICHE TECNICHE

Accensione Istantanea - Grado di protezione : IP20 - Dimensioni : Ø 37 x 98 mm
 Classe energetica A++ - CRI : >80% - Alimentazione : 220 / 240 Vac - 50 Hz
 Prodotto privo di Mercurio



4 w = **40 W**

470 lumen

Codice	Colore Luce	Confezione	EAN13
--------	-------------	------------	-------

CTFLTOR041430SM	Calda - 3000°K	10 pcs 100 pcs	 8 059016 272668
-----------------	----------------	-------------------	---------------------

CTFLTOR041440SM	Naturale - 4000°K	10 pcs 100 pcs	 8 059016 271081
-----------------	-------------------	-------------------	---------------------



Lampada LED Filamento a Oliva - 4 W - E14



4 w = **40** w

470 lumen

CARATTERISTICHE TECNICHE

Accensione Istantanea - Grado di protezione : IP20 - Dimensioni : Ø 37 x 98 mm
 Classe energetica A++ - CRI : >80% - Alimentazione : 220 / 240 Vac - 50 Hz
 Prodotto privo di Mercurio



30.000 h



200°



E14



Non dimmerabile



Codice

Colore Luce

Confezione

EAN13

CTFLOL041427CH *Calda - 2700°K*

10 pcs
100 pcs



Lampada LED Filamento a Oliva - 4 W - E14



4 w = **40** w

470 lumen

CARATTERISTICHE TECNICHE

Accensione Istantanea - Grado di protezione : IP20 - Dimensioni : Ø 37 x 98 mm
 Classe energetica A++ - CRI : >80% - Alimentazione : 220 / 240 Vac - 50 Hz
 Prodotto privo di Mercurio



30.000 h



200°



E14



Non dimmerabile



Codice

Colore Luce

Confezione

EAN13

CTFLOL041430SM *Calda - 3000°K*

10 pcs
100 pcs



CTFLOL041440SM *Naturale - 4000°K*

10 pcs
100 pcs





Lampada LED Filamento a Sfera - 4 W - E14

CARATTERISTICHE TECNICHE

Accensione Istantanea - Grado di protezione : IP20 - Dimensioni : Ø 45 x 78 mm
Classe energetica A++ - CRI : >80% - Alimentazione : 220 / 240 Vac - 50 Hz
Prodotto privo di Mercurio



Codice Colore Luce Confezione EAN13

CTFLG45041427CH Calda - 2700°K



10 pcs

100 pcs



4 w = **40 W**

470 lumen

Lampada LED Filamento a Sfera - 4 W - E14

CARATTERISTICHE TECNICHE

Accensione Istantanea - Grado di protezione : IP20 - Dimensioni : Ø 45 x 78 mm
Classe energetica A++ - CRI : >80% - Alimentazione : 220 / 240 Vac - 50 Hz
Prodotto privo di Mercurio



Codice Colore Luce Confezione EAN13

CTFLG45041430SM Calda - 3000°K



10 pcs

100 pcs



4 w = **40 W**

470 lumen



Lampada LED Filamento a Sfera - 4 W - E27



4 w = **40** w

470 lumen

CARATTERISTICHE TECNICHE

Accensione Istantanea - Grado di protezione : IP20 - Dimensioni : Ø 45 x 78 mm
 Classe energetica A++ - CRI : >80% - Alimentazione : 220 / 240 Vac - 50 Hz
 Prodotto privo di Mercurio



30.000 h



200°



E27



Non dimmerabile



Codice

Colore Luce

Confezione

EAN13

CTFLG45042727CH Calda - 2700°K



10 pcs

100 pcs



8 059016 272620

Lampada LED Filamento a Sfera - 4 W - E27



4 w = **40** w

470 lumen

CARATTERISTICHE TECNICHE

Accensione Istantanea - Grado di protezione : IP20 - Dimensioni : Ø 45 x 78 mm
 Classe energetica A++ - CRI : >80% - Alimentazione : 220 / 240 Vac - 50 Hz
 Prodotto privo di Mercurio



30.000 h



200°



E27



Non dimmerabile



Codice

Colore Luce

Confezione

EAN13

CTFLG45042730SM Calda - 3000°K



10 pcs

100 pcs



8 059016 272637



Lampadina Speciale per Cappe Aspiranti



E14



2.000 h



220 V

CARATTERISTICHE TECNICHE
 Alimentazione : 220/240 Vac 50 Hz
 Dimensioni : Ø 25 x 80 mm
 Prodotto privo di Mercurio

Codice
Confezione
EAN13
CT2580

10 pcs

50 pcs

CT40

10 pcs

50 pcs



Lampadina Speciale per Forni - 300°C



E14



1.000 h



220 V

CARATTERISTICHE TECNICHE
 Alimentazione : 220/240 Vac 50 Hz
 Dimensioni : Ø 22 x 48 mm
 Prodotto privo di Mercurio

Codice
Confezione
EAN13
CTF15

10 pcs

50 pcs

CTF25

10 pcs

50 pcs



Lampadina Speciale per Frigoriferi



E14



2.000 h



220 V

CARATTERISTICHE TECNICHE
 Alimentazione : 220/240 Vac 50 Hz
 Dimensioni : Ø 25 x 56 mm
 Prodotto privo di Mercurio

Codice
Confezione
EAN13
CTFR15

10 pcs

50 pcs





Lampadina Speciale per Macchine da Cucire



CARATTERISTICHE TECNICHE

Alimentazione : 220/240 Vac 50 Hz

Dimensioni : Ø 16 x 45 mm

Prodotto privo di Mercurio

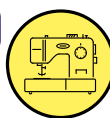

BA15D



2.000 h



220 V

Codice

Confezione

EAN13

15
Watt

CTM15



10 pcs

50 pcs



8 059016 271791

Lampadina Speciale ad Incandescenza



CARATTERISTICHE TECNICHE

Alimentazione : 220/240 Vac 50 Hz

Dimensioni : Ø 16 x 49 mm

Prodotto privo di Mercurio



E14



2.000 h



220 V

Codice

Confezione

EAN13

10
Watt

CT3



10 pcs

50 pcs



8 059016 271784

Lampadina Speciale ad Incandescenza



CARATTERISTICHE TECNICHE

Alimentazione : 220/240 Vac 50 Hz

Dimensioni : Ø 22,5 x 54 mm

Prodotto privo di Mercurio



E14



2.000 h



220 V

Codice

Confezione

EAN13

7,5
Watt

CT75E14



10 pcs

50 pcs



8 059016 271821



Lampadina Speciale ad Incandescenza

CARATTERISTICHE TECNICHE

Alimentazione : 24 V

Dimensioni : Ø 23 x 52 mm

Prodotto privo di Mercurio



E14



2.000 h



24 V

Codice

Confezione

EAN13

CT3W24V



10 pcs

50 pcs



Lampadina Speciale ad Incandescenza

CARATTERISTICHE TECNICHE

Alimentazione : 220/240 V

Dimensioni : Ø 26 x 57 mm

Prodotto privo di Mercurio



E14



2.000 h



220 V

Codice

Confezione

EAN13

CT7



10 pcs

50 pcs



CT15



10 pcs

50 pcs



CT2557



10 pcs



50 pcs



Portalampada E27 in porcellana - Bianco





Portalampada vintage in porcellana colore bianco con attacco E27. Compatibile con tutti i cavi elettrici bipolari e tripolari Serracavi inclusi.

Codice	Confezione	EAN13
CTAC995	 1 pcs	
	 10 pcs	

Portalampada passante E27 in porcellana



Portalampada passante vintage in porcellana di colore bianco con connessione E27. Compatibile con tutti i cavi elettrici bipolari e tripolari. Serracavi inclusi.

Codice	Confezione	EAN13
CTAC162	 1 pcs	
	 10 pcs	

Applique E27 in porcellana - Base dritta









CTAC500
Bianco



CTAC501
Nero

Applique in porcellana base dritta. Diametro 75mm, Altezza 65mm, Portalamppada con attacco E27 e kit accessori inclusi.

Codice	Confezione	EAN13
CTAC500	 1 pcs	
	 10 pcs	
CTAC501	 1 pcs	
	 10 pcs	

Applique E27 in porcellana - Base inclinata

Applique in porcellana per installazioni a parete con base inclinata.

Diametro 75mm, Altezza 65mm

Portalampana con attacco E27.



CTAC511
Nero

CTAC510
Bianco



Codice	Confezione	EAN13
CTAC510	1 pcs	8 054521 566714
	10 pcs	
CTAC511	1 pcs	8 054521 566721
	10 pcs	

Rosone in porcellana bianco

Rosone in porcellana bianco ad un foro, diametro 100mm, altezza 30mm con accessori in dotazione. Compatibile con qualsiasi cavo elettrico.



Codice	Confezione	EAN13
CTAC923	1 pcs	8 054521 560705
	10 pcs	

Deviatore in porcellana bianco

Deviatore vintage in porcellana colore bianco.

Diametro 85mm, altezza 40mm.

Accessori inclusi per installazioni a parete.





Codice	Confezione	EAN13
CTAC415	1 pcs	8 054521 560712
	10 pcs	

Presa Bipasso in porcellana bianco





Presa bipasso vintage in porcellana colore bianco.
Diametro 85mm, altezza 40 mm.
Accessori per l'installazione a parete inclusi.

Codice	Confezione	EAN13
CTAC430	 1 pcs	
	 10 pcs	

Presa Schuko in porcellana bianco





Presa schuko in porcellana versione vintage di colore bianco.
Diametro 85 mm, altezza 40 mm.
Kit accessori per installazioni a parete inclusi.

Codice	Confezione	EAN13
CTAC433	 1 pcs	
	 10 pcs	

Scatola di derivazione in porcellana bianco



Scatola di derivazione in porcellana con quattro uscite laterali,
diametro 100mm, altezza 40mm. Kit accessori per impianti a
parete inclusi.

Codice	Confezione	EAN13
CTAC448	 1 pcs	
	 10 pcs	

Isolatore in porcellana bianco

Isolatore vintage in porcellana di colore bianco per installazioni a parete. Compatibile con qualsiasi cavo bipolare e tripolare. Diametro 18 mm, Altezza 20 mm. Con vite e tassello inclusi



Codice	Confezione	EAN13
--------	------------	-------

CTAC402

 10 pcs

 100 pcs



Pendente assemblato Tazza da cappuccio

Pendente cablato a forma di tazza da cappuccino in porcellana bianca, portalamпада E27, rosone bianco e cavo tondo bipolare nero. Made in Italy. Cavo da 2 mt. Lampadina non inclusa.



Codice	Confezione	EAN13
--------	------------	-------

CTAT600

 1 pcs

 4 pcs



Pendente assemblato Tazzina da caffè

Pendente assemblato a forma di tazzina da caffè in porcellana bianca. Portalamпада E27, rosone bianco e cavo tondo bipolare rosso. Made in Italy. Cavo da 2 mt. Lampadina non inclusa.



Codice	Confezione	EAN13
--------	------------	-------

CTAT700

 1 pcs

 4 pcs



Cavo Elettrico rivestito in tessuto intrecciato



Bianco



Nero



Marrone



Juta



Oro



Argento

Completamente realizzato in Italia, il cavo a due e a tre fili, garantisce un'ottima elasticità e flessibilità dal momento che utilizziamo un modello di cavo H03VV-F morbido a doppio isolamento che rispetta la certificazione di prodotto IMQ-HAR. Matassa da 3 mt in confezione appendibile.



Codice	Colore	Sezione	Confezione	EAN13
CTAX704	Bianco	2 x 0,75 mm ²	1 pcs 10 pcs	8 054521 564208
CTAX754	Bianco	3 x 0,75 mm ²	1 pcs 10 pcs	8 054521 564758
CTAX713	Nero	2 x 0,75 mm ²	1 pcs 10 pcs	8 054521 564222
CTAX763	Nero	3 x 0,75 mm ²	1 pcs 10 pcs	8 054521 566165
CTAX712	Marrone	2 x 0,75 mm ²	1 pcs 10 pcs	8 054521 565977
CTAX762	Marrone	3 x 0,75 mm ²	1 pcs 10 pcs	8 054521 564802
CTAX374	Juta	2 x 0,75 mm ²	1 pcs 10 pcs	8 054521 567902
CTAX474	Juta	3 x 0,75 mm ²	1 pcs 10 pcs	8 054521 568664
CTAX160	Oro	2 x 0,75 mm ²	1 pcs 10 pcs	8 054521 566073
CTAX170	Oro	3 x 0,75 mm ²	1 pcs 10 pcs	8 054521 564482
CTAX156	Argento	2 x 0,75 mm ²	1 pcs 10 pcs	8 054521 564468
CTAX166	Argento	3 x 0,75 mm ²	1 pcs 10 pcs	8 054521 564499

Cavo Elettrico rivestito in tessuto tondo

Completamente realizzato in Italia, il cavo a due e a tre fili, garantisce un'ottima elasticità e flessibilità dal momento che utilizziamo un modello di cavo H03VV-F morbido a doppio isolamento che rispetta la certificazione di prodotto IMQ-HAR. Matassa da 3 mt in confezione appendibile.



Bianco



Nero



Marrone



Juta



Oro



Argento



Codice	Colore	Sezione	Confezione	EAN13
CTAX501	Bianco	2 x 0,75 mm ²	1 pcs	8 054521 566332
			10 pcs	
CTAX601	Bianco	3 x 0,75 mm ²	1 pcs	8 054521 566202
			10 pcs	
CTAX510	Nero	2 x 0,75 mm ²	1 pcs	8 054521 565793
			10 pcs	
CTAX610	Nero	3 x 0,75 mm ²	1 pcs	8 054521 565670
			10 pcs	
CTAX509	Marrone	2 x 0,75 mm ²	1 pcs	8 054521 566240
			10 pcs	
CTAX609	Marrone	3 x 0,75 mm ²	1 pcs	8 054521 564604
			10 pcs	
CTAX566	Juta	2 x 0,75 mm ²	1 pcs	8 054521 565557
			10 pcs	
CTAX666	Juta	3 x 0,75 mm ²	1 pcs	8 054521 565939
			10 pcs	
CTAX530	Oro	2 x 0,75 mm ²	1 pcs	8 054521 566080
			10 pcs	
CTAX630	Oro	3 x 0,75 mm ²	1 pcs	8 054521 565656
			10 pcs	
CTAX531	Argento	2 x 0,75 mm ²	1 pcs	8 054521 564529
			10 pcs	
CTAX631	Argento	3 x 0,75 mm ²	1 pcs	8 054521 567025
			10 pcs	



WORK LIGHT LED

HQ
HIGHEST
QUALITY

→ 200
LUMEN

→ 200
mt

Base
Magnetica



Base Magnetica

ESPOSITORE DA BANCO 12 pcs



SORGENTE LUMINOSA : 1 COB

LUMINOSITA' : 200 Lm

DURATA : 2 ore

MODALITA' DI ILLUMINAZIONE : Interruttore On / Off

TIPO DI BATTERIA : 3 x AAA (non incluse)

MATERIALE : ABS con magnete alla base e gancio

DIMENSIONI : 16 x 5 x 4,4 cm

PESO : 54 gr

Codice

Confezione

EAN13

CT2098

12 pcs
48 pcs



8 059016 271128



WORK LIGHT LED



Clip per fissaggio a cintura



Gancio



Base Magnetica



ESPOSITORE DA BANCO 12 pcs



SORGENTE LUMINOSA : 1 LED (superiore) + COB (inferiore)

LUMINOSITA' :

- Superiore : 200 Lm

- Inferiore : 200 Lm

DURATA : 2 ore LED / 2 ore COB

MODALITA' DI ILLUMINAZIONE : Superiore / Inferiore

TIPO DI BATTERIA : 3 x AAA (non incluse)

MATERIALE : ABS con tasto morbido, magneti alla base, gancio e clip

DIMENSIONI : 11,5 x 5 x 4,5 cm

PESO : 70 gr

Codice

Confezione

EAN13

CT2096



12 pcs

48 pcs



8 059016 271111



FLASH LIGHT LED

HQ
HIGHEST
QUALITY



300
mt

3 Modalità

1 360
LUMEN

2 100
LUMEN

3 FLASH



ESPOSITORE DA BANCO 12 pcs



SORGENTE LUMINOSA : 1 LED

LUMINOSITA': 360 Lm

DURATA : 2 ore

MODALITA' DI ILLUMINAZIONE : Luce intensa, luce debole, flash, zoom

TIPO DI BATTERIA : 3 X AAA (non incluse)

MATERIALE : Alluminio

DIMENSIONI : 11,4 x 3,4 cm

PESO : 116 gr

Codice

Confezione

EAN13

CT1009

12 pcs
72 pcs



FLASH LIGHT LED



Base Magnetica

HQ
HIGHEST
QUALITY



→ 300
mt

5 Modalità

1 → 100
LUMEN

2 → 400
LUMEN

3 → FLASH

4 → 90
LUMEN

5 → 40
LUMEN

DUAL LED

→ 100
mt

Base
Magnetica

SORGENTE LUMINOSA : 3 W LED (frontale) + 2 W COB (laterale)

LUMINOSITA' :

- **Frontale** : 100 Lm Luce intensa / 40 Lm Luce debole
- **Laterale** : 90 Lm Luce intensa / 40 Lm Luce debole

DURATA : 8 ore Luce intensa - 20 ore Luce debole

MODALITA' DI ILLUMINAZIONE :

- **Frontale** : Luce intensa / Luce debole / Flash
- **Laterale** : Luce intensa / Luce debole

TIPO DI BATTERIA : 3 X AAA (non incluse)

MATERIALE : Alluminio, ABS, Magnete

DIMENSIONI : 14,5 x 5 cm

PESO : 129 gr



Codice

Confezione

EAN13

CT1015



6 pcs

48 pcs



8 059016 270169



HEAD LIGHT LED



- 3 Modalità
- 150 LUMEN
- 75 LUMEN
- STROBO
- 180°
- COB
- 130 mt



SORGENTE LUMINOSA : 3 W COB
LUMINOSITA' : 150 Lm (luce intensa) - 75 Lm (Luce debole)
DURATA : 3 ore (Luce intensa) - 5 ore (Luce debole)
MODALITA' DI ILLUMINAZIONE : Luce intensa, luce debole, flash
TIPO DI BATTERIA : 3 X AAA (non incluse)
MATERIALE : ABS, PS
DIMENSIONI : 7 x 4 x 5,5 cm
PESO : 90 gr

Codice Confezione EAN13

CT7021

5 pcs
 30 pcs





HEAD LIGHT LED



- 5 Modalità
- 1 250 LUMEN
- 2 120 LUMEN
- 3 FLASH
- 4 LUCE BIANCA
- 5 LUCE ROSSA
- 250 mt
- 30°
-

SORGENTE LUMINOSA : LED 3 W + COB 3 W
LUMINOSITA': 250 Lm (luce LED intensa) - 120 Lm (Luce LED debole)
 250 Lm (LED COB)
DURATA : 2 ore (Luce LED intensa) - 4 ore (Luce LED debole)
 3,5 ore (LED COB)
MODALITA' DI ILLUMINAZIONE : Luce LED intensa, luce LED debole,
 Luce COB bianca, Luce COB Rossa, Flash COB Rosso
TIPO DI BATTERIA : 3 X AAA (non incluse)
MATERIALE : ABS
DIMENSIONI : 6 x 6 x 4,5 cm
PESO : 48 gr



Codice

Confezione

EAN13

CT7031



6 pcs

48 pcs



8 059016 271142



TELEKOMANDI

<i>Telecomandi TV Universali</i>	<u>71</u>
<i>Telecomandi TV Programmabili</i>	<u>72</u>
<i>Radiocomandi Apricancello</i>	<u>73</u>



Telecomandi Universali



Inquadra il QRCode con il tuo Smartphone per visualizzare l'elenco aggiornato dei modelli compatibili

- Compatibile con la maggior parte dei modelli TV LCD, Plasma e LED
- Pronto all'uso. Basta inserire le batterie. Non necessita di alcuna programmazione
- Mantiene i codici durante il cambio batterie
- Alimentazione 2 x batterie AAA (ministilo) - Non Include

Codice	Marca	Confezione	EAN13
--------	-------	------------	-------

READY 1	SAMSUNG	1 pcs	8 059016 271920
---------	---------	-------	-----------------

READY 2	LG	1 pcs	8 059016 271937
---------	----	-------	-----------------

READY 3	SONY	1 pcs	8 059016 271944
---------	------	-------	-----------------

READY 4	PHILIPS	1 pcs	8 059016 271951
---------	---------	-------	-----------------

I marchi citati sono registrati e di proprietà degli aventi diritto. Vengono menzionati al solo scopo di indicare la compatibilità del prodotto, ai fini di un corretto utilizzo da parte del consumatore.



Telecomandi programmabili



- Telecomando programmabile con facilità.
- Sostituisce le principali funzioni degli apparecchi TV, VCR, DVD (Contakt 3 anche SAT o SKY)
- Accesso diretto ai servizi SMARTTV
- Programmabile tramite PC il cui database viene aggiornato mensilmente con i nuovi telecomandi presenti sul mercato.
- Per la programmazione è necessario il cavo e il software forniti separatamente
- Mantiene i codici memorizzati durante il cambio delle batterie
- Alimentazione 2 x batterie AAA (ministilo) - Non Include

Codice	Unità comandabili	Confezione	EAN13
--------	-------------------	------------	-------

CONTACT 1	1 TV - DTT - VCR o DVD	1 pcs	8 059016 271906
CONTACT 3	3 TV - DTT - VCR - DVD - SAT o SKY	1 pcs	8 059016 271913

Radiocomandi Universali Multifrequenza

Frequenza MHz : Multy AM-FM

Numero di canali : 4

Tipo di codice : Fisso & Rolling

Batteria : 1 x CR2032 (inclusa)



CT4791010



CT4791011



CT4791012



CT4791013

Codice	Colore	Confezione	EAN13
CT4791010	Nero	 1 pcs	 3 863349 213145
CT4791011	Bianco	 1 pcs	 3 863349 213152
CT4791012	Rosso	 1 pcs	 3 863349 213169
CT4791013	Blu	 1 pcs	 3 863349 213176



CONTACT172	CT1003N3	CT1018B7
CONTACT372	CT1004B8	CT1018N7
CT015F39	CT1004N8	CT1019B6
CT01B27	CT1005B4	CT1019N6
CT01N27	CT1005BSP5	CT1020B12
CT025F39	CT1005N4	CT1021B12
CT025M38	CT1005NSP5	CT10F39
CT02B27	CT1006B4	CT10M38
CT02N27	CT1006N4	CT12018272745
CT04CH37	CT1007B6	CT12018274045
CT04F39	CT1008B7	CT12018276545
CT04M38	CT1008N7	CT12524272746
CT05CH37	CT100966	CT12524274046
CT06CH37	CT1010B10	CT12M38
CT06F39	CT1010N10	CT1557
CT06M38	CT1012B10	CT1510B35
CT07CH37	CT1012N10	CT1510G35
CT08CH37	CT1014B11	CT1510N35
CT1000B5	CT1014N11	CT1510R35
CT1000N5	CT101567	CT165STRING37
CT1001B3	CT1015B9	CT16F39
CT1001N3	CT1015N9	CT16M38
CT1002B8	CT1016B9	CT1925B35
CT1002N8	CT1016N9	CT1925G35
CT1003B3	CT1017B11	CT1925N35



CT1925R35	CT25100N36	CT3005N22
CT2003B13	CT2525B35	CT3006B23
CT2003N13	CT2525G35	CT3006N23
CT2004B13	CT2525N35	CT3007B23
CT2004N13	CT2525R35	CT3007N23
CT2005B14	CT255757	CT3008B23
CT2005N14	CT258055	CT3008N23
CT2006B14	CT25F39	CT3010A24
CT2006N14	CT285STRING37	CT3020A24
CT2008BSC17	CT2BL50	CT36140B36
CT2008NSC17	CT2G50	CT36140N36
CT2009BSC17	CT2LC2449	CT36200B36
CT2009NSC17	CT2R50	CT36200N36
CT2010B19	CT2V50	CT36300B36
CT2011B20	CT2W14B50	CT36300N36
CT2012USB15	CT356	CT3706142742
CT2013B15	CT3001B21	CT3706144042
CT2014B16	CT3001N21	CT3706146542
CT2015B16	CT3002B21	CT3708142743
CT2020B18	CT3002N21	CT3708144043
CT2021B19	CT3003B21	CT3708146543
CT209665	CT3003N21	CT3W24V57
CT209864	CT3004B22	CT4055
CT2103B18	CT3004N22	CT400125
CT25100B36	CT3005B22	CT400225



CT4003	26	CT48350N	36	CTAC501	59
CT4004	26	CT60102727	41	CTAC510	59
CT45061427	43	CT60102740	41	CTAC511	59
CT45061440	43	CT60102765	41	CTAC923	60
CT45061465	43	CT60122727	41	CTAC995	58
CT45062727	44	CT60122740	41	CTAT600	60
CT45062740	44	CT60122765	41	CTAT700	60
CT45062765	44	CT60172727	42	CTAX156	62
CT45081427	44	CT60172740	42	CTAX160	62
CT45081440	44	CT60172765	42	CTAX166	62
CT45081465	44	CT68180B	36	CTAX170	62
CT45082727	45	CT68180N	36	CTAX374	62
CT45082740	45	CT68250B	36	CTAX474	62
CT45082765	45	CT68250N	36	CTAX501	63
CT46120B	36	CT7	57	CTAX509	63
CT46120N	36	CT7021	68	CTAX510	63
CT46180B	36	CT7031	69	CTAX530	63
CT46180N	36	CT75E14	56	CTAX531	63
CT4791010	73	CTAC162	58	CTAX566	63
CT4791011	73	CTAC402	62	CTAX601	63
CT4791012	73	CTAC415	61	CTAX609	63
CT4791013	73	CTAC430	61	CTAX610	63
CT48300B	36	CTAC433	61	CTAX630	63
CT48300N	36	CTAC448	62	CTAX631	63
CT48350B	36	CTAC500	58	CTAX666	63

CTAX704	62	CTG530727	46
CTAX712	62	CTG530740	46
CTAX713	62	CTG935220	49
CTAX754	62	CTM15	56
CTAX762	62	CTR50071430	47
CTAX763	62	CTR50071440	47
CTCOAX2MTB	33	CTR63102730	48
CTCOAX2MTN	33	CTR63102740	48
CTCOAX3MTB	33	CTR80152730	48
CTCOAX3MTN	33	CTR80152740	48
CTCOAX5MTB	33	CTSAT5100B	31
CTCOAX5MTN	33	CTSAT5150A	29
CTF15	55	CTSAT7100A	30
CTF25	55	CTSAT7100B	32
CTFLG45041427CH .53		CTSATC51F	33
CTFLG45041430SM .53		CTSATC68F	33
CTFLG45042727CH .54		READY1	71
CTFLG45042730SM .54		READY2	71
CTFLOL041427CH .52		READY3	71
CTFLOL041440SM .52		READY4	71
CTFLTOR041427CH .51			
CTFLTOR041440SM .51			
CTFR15	55		
CTG100827	47		
CTG100840	47		



Dove siamo



Assisi s.n.c.
Via Vado della Valle, 12 - 10022 Carmagnola (TO)
Tel (+39) 011 971.23.48
Fax (+39) 011 971.61.86
assisi@assisi.it - www.assisi.it

Il nostro sito web

